

MONNO
KITCHEN APPLIANCES COLLECTION

Over 40 years ago, I started with nothing but knowledge, determination, and a belief that things could be done better.



Step by step, we built a family business grounded in experience, responsibility, and constant development. What began as a small initiative has grown into a company producing around **800,000 products each year** - something I could have never imagined back then! And yet, we continue to move forward without losing what matters most: **relationships, trust, and our family character.**

Every challenge, every innovation, every patent brought us closer to a moment when we knew we were ready to go further.

MONNO is that moment.

It reflects a shift in how we think - where design is no longer a finishing touch, but the core of everything we do. Design is our strategy and the foundation of MONNO. It defines how our products work, how they fit into space, and how they are experienced every day.

For me, MONNO is a natural continuation of everything we have learned - but also a **new beginning.**

I invite you to discover our story.

Founder&CEO



THE INDUSTRY'S BEST KEPT SECRET

MONNO is driven by design and innovation - not as an addition, but as the foundation.

With over **40 years of expertise**, we approach ventilation with a clear intention: to take control of air and redefine how it performs in everyday use.

Engineering and design work as one, shaping solutions that are precise, efficient, and built with purpose.

Fully designed and produced in Europe, MONNO stands apart from mass production-delivering a level of quality and performance that cannot be replicated at scale.

WHERE IT ALL BEGAN

In the **Bieszczady Mountains** defined by silence, pure air, and the strength of nature – our story began over **40 years ago**. This is where we built our factory in **Sanok**, developed our expertise, and shaped the way we think about air.

This environment continues to influence everything we create – where precision, control, and devotion to **air quality** are not just features, but fundamentals.

Sanok has always been more than a location. It is a place shaped by **craftsmanship and artistic sensitivity**, known for the legacy of Zdzisław Beksiński – Poland’s most distinctive and internationally recognized artists. This connection to form, detail, and expression has naturally accompanied us, influencing how we approach design today.

BRAND PORTFOLIO

ONE GROUP. MULTIPLE STRENGTHS



MONNO represents a new chapter – a response to evolving expectations and a shift in product thinking. **Built on design and innovation, and powered by the experience of the entire group**, it delivers a new standard of performance shaped by intention, precision, and design.



Own Brand (Central Europe)
Headquartered in Warsaw, Ciarko Design is the group's brand for Central and Eastern Europe. **A leading brand in the premium cooker hood** segment in Poland and the Czech Republic, and a multiple award-winning brand recognized for **design, quality, and innovation**.



OEM Manufacturer – based in Sanok, Poland, Ciarko is one of Europe's leading manufacturers of kitchen ventilation systems. With over 40 years of expertise and an annual production of around **800,000** units, its products are present in over **40 markets** worldwide. **A reliable OEM partner combining advanced engineering, scale, and patented technologies**.



HQ (Ciarko Design) - Warsaw

Production facility - Sanok

PRODUCTION

Built under one roof.
Driven by people
& technology.

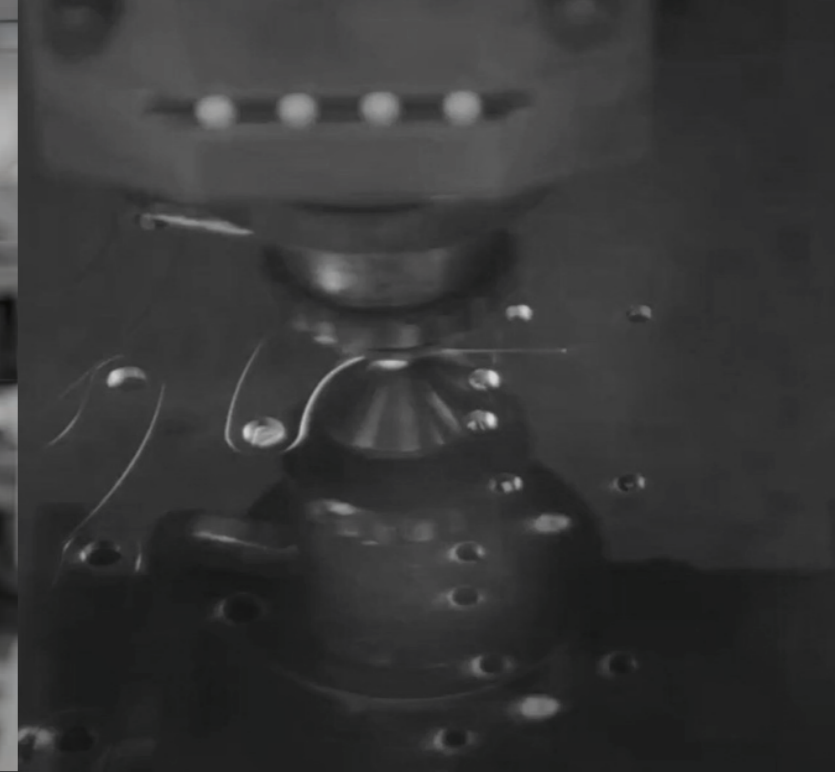

Designed and manufactured in Europe, with production reaching up to **3,500 cooker hoods** per day across 20,000 m².

Over **500 specialists** and a robotisation level more than twice the national average allow us to combine speed, scale and repeatability with full control.

Automation drives efficiency.
People define the final result.

From R&D and in-house laboratory testing to production and logistics – every stage happens under one roof. This gives us full control over quality and development speed.

Industrial technology gives us power.
Our soul is in the details.

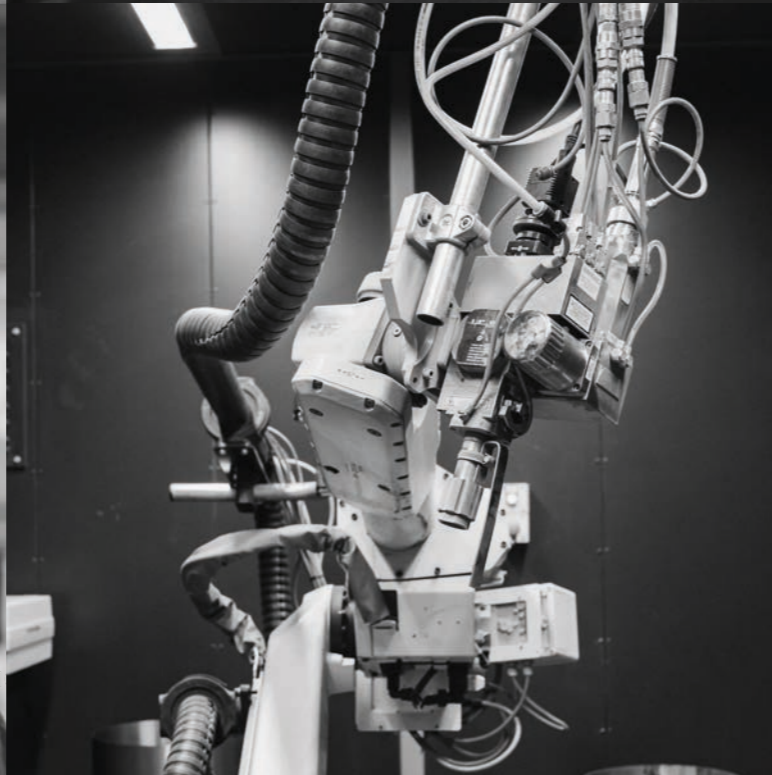



OUR VISION

*„We draw the world into products full of design
and innovation, shaping the future.“*

**DESIGN.
PRECISION.
INNOVATION.**

DESIGN

Design is not an end. It is our foundation.16





Good design is visible.
Great design is experienced.

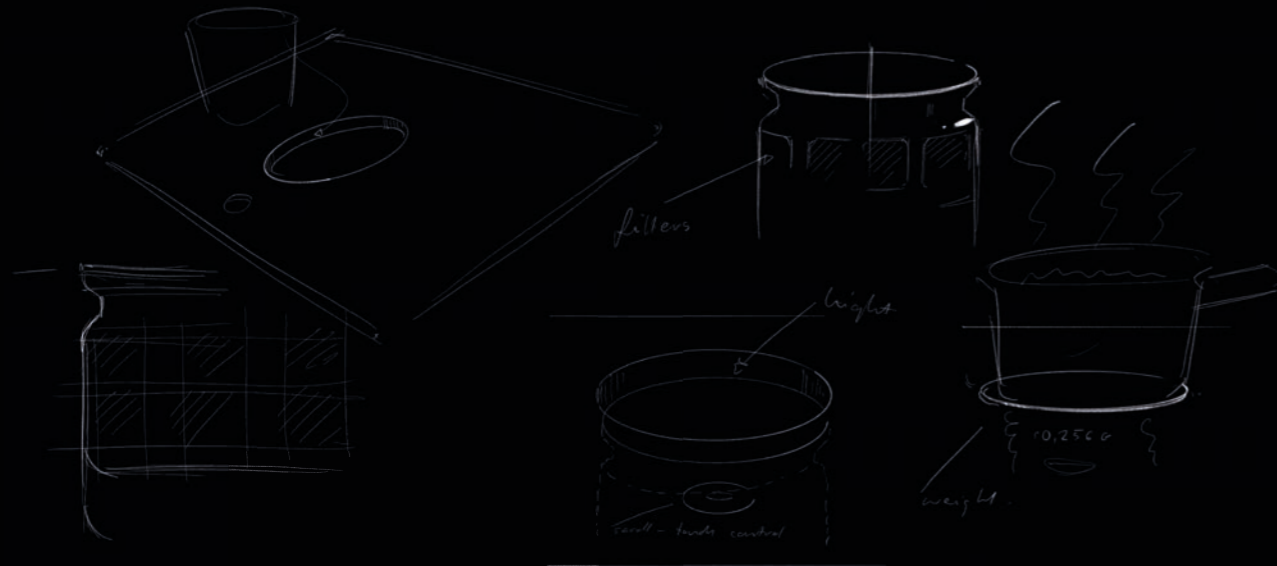

Mikołaj Nicer

Nicer Design

Since the 1990s, design has shaped the way we think and create. From the beginning, we chose **to go beyond convention** - with a bold and uncompromising approach to what products should be.

Never afraid to be different - to take our own path and create solutions that stand apart.

How people live, cook and use their kitchens - that is our real commitment to **understanding what truly matters before creating**.

Form and function should never compete - they should work as one, guided by shared discipline and attention to detail.

We value and embrace Design as part of our company DNA.

Together with selected studios, such as **Nicer Design**, we challenge perspectives and redefine standards.

Our awards:



reddot





INNOVATION

Innovation is a word used by everyone.
For us, it is what we have been doing for decades.



Over the years, we have introduced solutions that redefined the industry—including pioneering **gesture control** in 2018, which set a new **global benchmark for intuitive interaction**.

Our approach is grounded in real engineering, in-house development and patented solutions. **From intelligent air management and modular systems, to connectivity, sensors and advanced filtration technologies** — every idea starts with a need to address and ends with a working solution.

We are guided by a simple but powerful motto from our founder:
„Continuously develop, improve and move forward.“

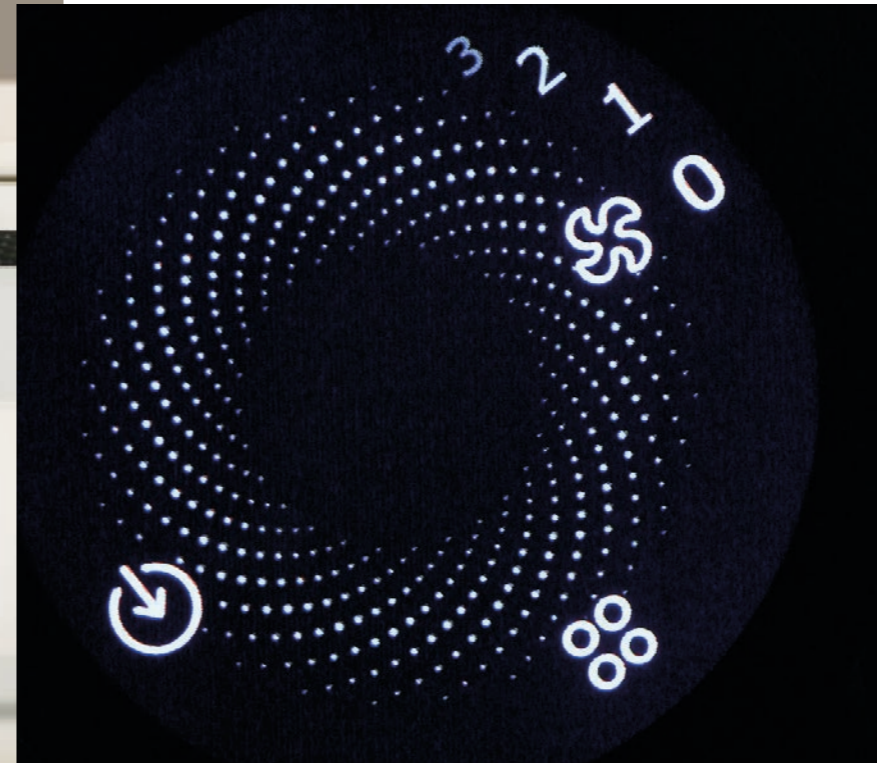

Wall-e: Shaping the future of intelligent kitchen solutions.

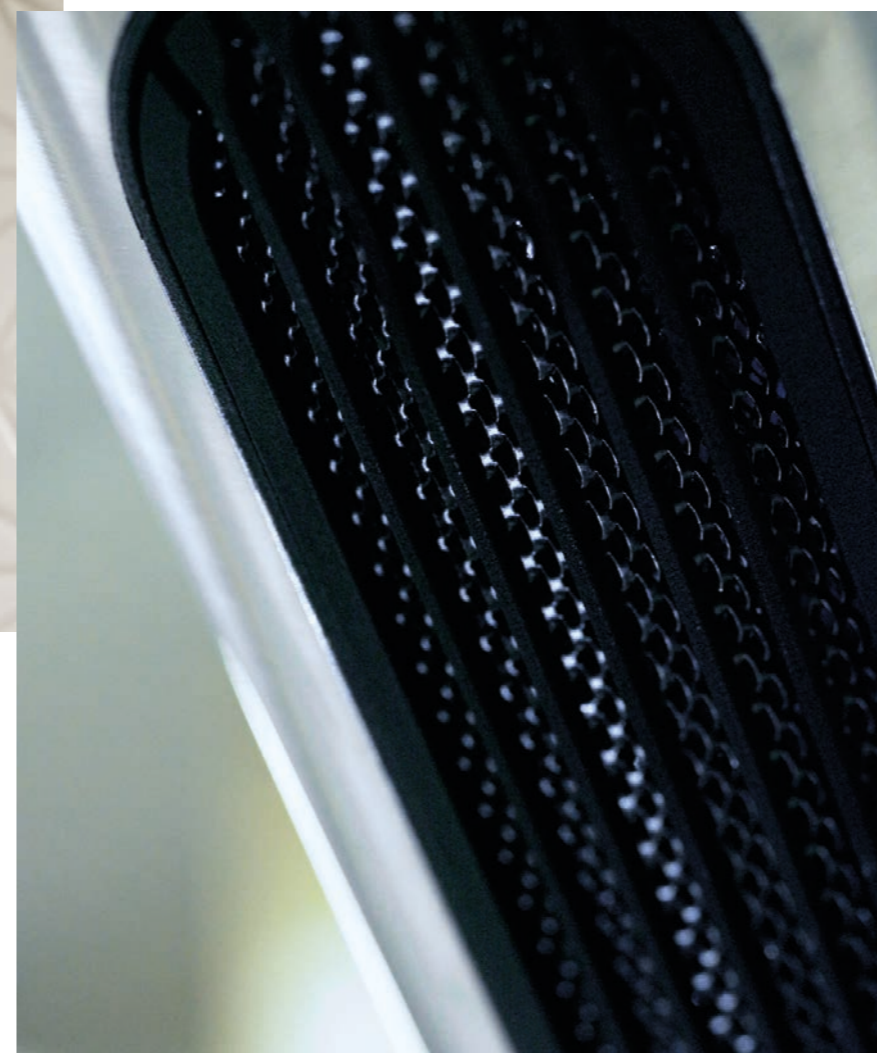

Back to 2004.
We were the first to introduce a kitchen hood with a built-in television more than **20 years ago**.



PRECISION

Precision is our dedication to those who expect more.

That's what makes the difference.



It's in the way we approach **every detail** with care, focus and the willingness to spend more time on what others might overlook.

We go back, check again, refine.

Not because we have to, but because we want the result to feel right. Because we know that even the smallest element matters — in how a product works, looks and is experienced every day.



MARKETING

Marketing is not decoration. It is our voice.

MONNO®





**We're not a black and white appliance brand.
We don't believe in neutral, safe choices.**

We create for people who want more – more character, more intention, more from the everyday.

Being a statement doesn't always mean a decorative hood. It means that whatever we create **in every category** carries personality, confidence and a clear point of view.

**We've never wanted to fit in.
And we still don't.**



PEOPLE

Where it all comes together.

In real homes.
In everyday moments.
This is where it truly matters.
Welcome to the world of MONNO.

 **MONNO**[®]



That's what makes us special!



DESIGN award-winning internationally.

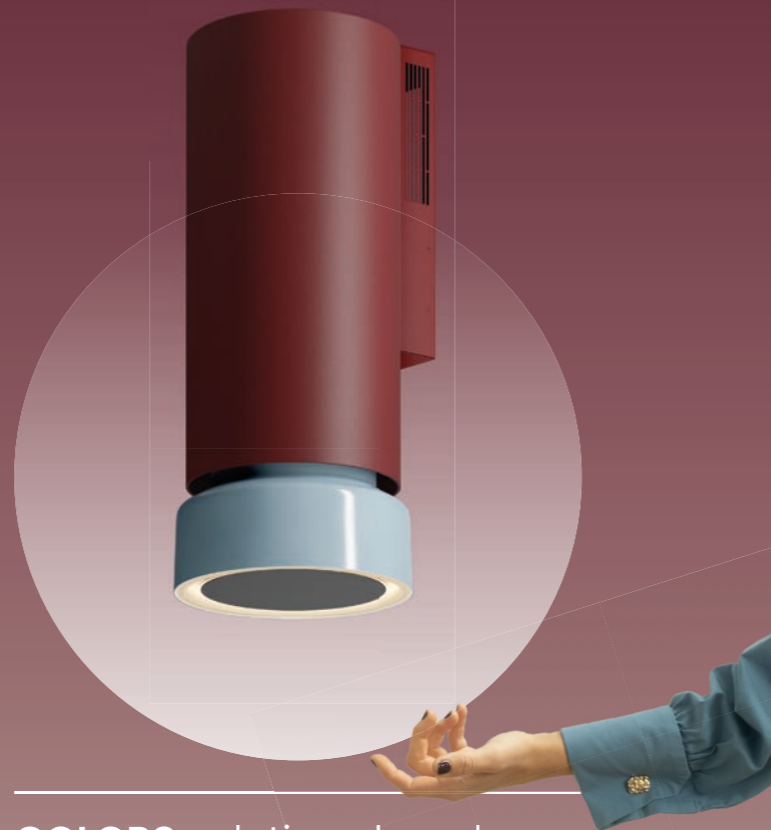

COLORS solutions loved by architects.



ANTIFINGER PRINT
Perfectly smooth surface resistant to scratches and imprints.



Warm2Cold LED
- adjustable lighting colour (2900 K - 6000 K).



GESTURE CONTROL or remote control.



HANDCRAFTED IN EU
production in Poland, Sanok.



Quiet, brushless and energy-efficient **BLDC** engine.



Possibility of **LOW HANGING** above the induction hob - min. 45 cm.

01

TECHNOLOGIES

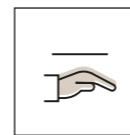

GestureControl

Control your hood completely touch-free with simple hand movements. Switch the appliance on or off and adjust power or lighting effortlessly, no contact required.

Integrated motion sensors ensure intuitive operation and maximum convenience, even during intensive cooking. No interruptions, no wiping hands and no fingerprints on the control panel.

Key Benefits:

- **Maximum Hygiene:** Touchless operation prevents smudges and keeps the panel clean
- **Intuitive Operation:** Natural hand gestures enable quick and easy control
- **Seamless Workflow:** No need to interrupt cooking or clean your hands
- **Precise Control:** Easily adjust ventilation power and lighting with simple gestures

Keeping the hood clean and controlling its operation has never been easier:

1

By holding your hand in front of the hood for about 2 sec, you will turn on the lighting.

2

Move your hand from left to right to change the speed mode to a higher one.

3

Shift to a lower gear by moving your hand from right to left and stop for about 2 seconds to turn off the lights.



Remote control

Enhances user convenience by enabling remote operation of the appliance without the need to approach it. Our devices use **radio technology**, which provides greater precision and range. Thanks to its **magnetic casing**, the remote can be easily attached to a metal surface, making it convenient to store and harder to misplace. It also complements modern features such as gesture control, offering greater flexibility in use.

Remote control functions:



turning the hood on and off



adjusting power levels



controlling the color and intensity of lighting



activating additional functions – Timer

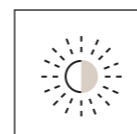

Warm2ColdLED

If you're unsure whether to choose warm or cool light, Monno helps you eliminate that dilemma once and for all. **Warm2ColdLED** technology allows you to adjust the light color temperature from **2900K to 6000K**. Warm light, similar to natural sunlight, is easy on the eyes and enhances well-being. Cooler light, on the other hand, highlights details and emphasizes the character of the interior.

Beyond offering endless possibilities for kitchen design, **Warm2ColdLED** has another key advantage: it illuminates the workspace while consuming minimal energy—regardless of the time of day or weather conditions outside.

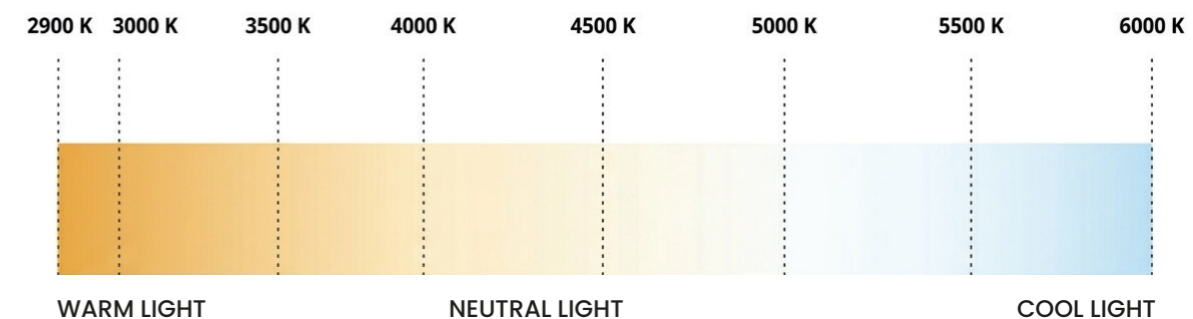

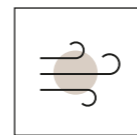

Air Refresh Function

Keep your kitchen air **continuously fresh**, even when you're not cooking. The Air Refresh function **automatically activates the hood at regular intervals**, maintaining gentle air circulation throughout the day.

This effectively removes lingering odors, excess moisture and stale air before they accumulate, creating a more comfortable and healthier indoor environment. The system operates fully automatically in pre-programmed cycles, requiring no user interaction.

Thanks to its low-speed operation, the function runs **quietly and energy-efficiently**, making it ideal for continuous use without disturbing everyday activities.

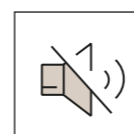
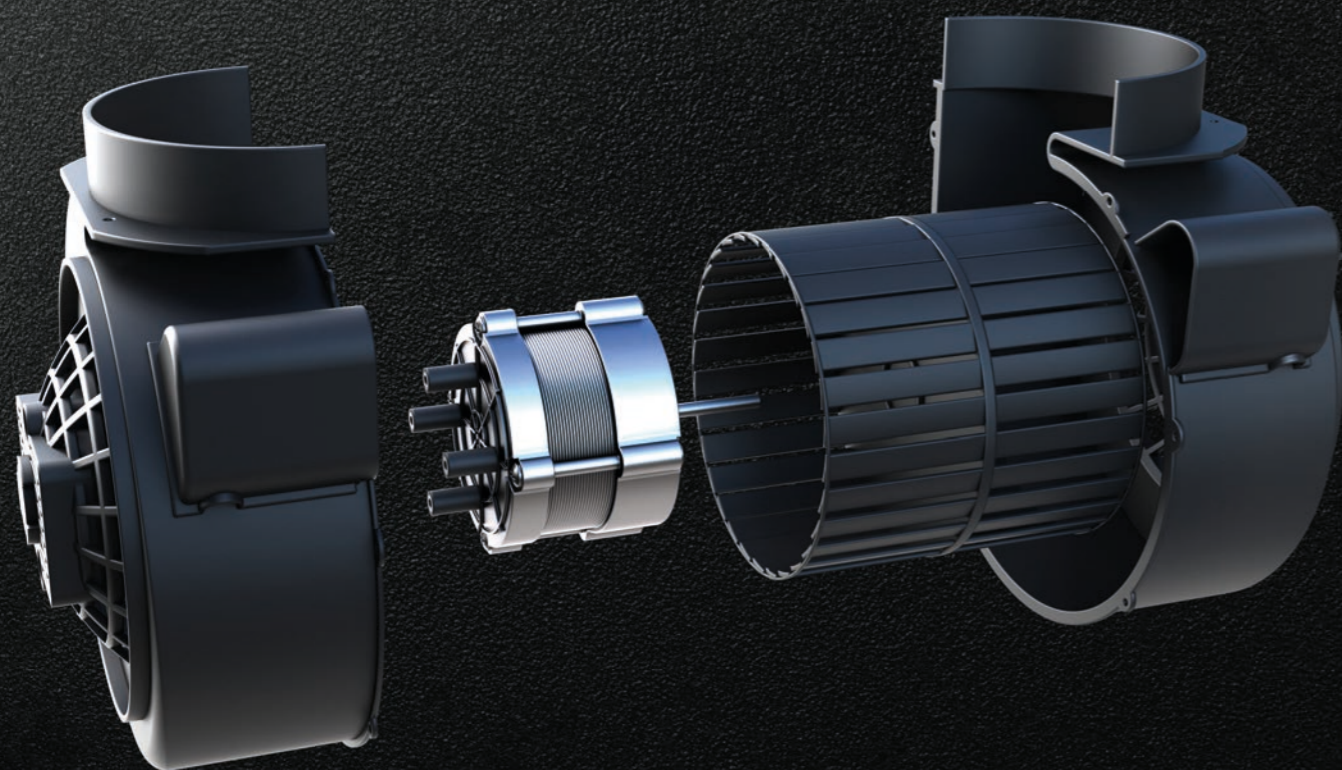

Motor BLDC

What do we pay attention to when choosing a kitchen hood? Reliable research shows that the key factors are noise level and performance. Understanding these needs, and backed by years of experience, we offer products that perfectly meet these expectations.

Our devices combine high quality—driven by technology developed **in Poland** - with the expertise of engineers from the Warsaw University of Technology, who worked on the heart of the hood: the **BLDC** motor.

It operates extremely quietly and achieves an **A+++** energy rating, reducing energy consumption by up to **95%**. On its lowest setting, it requires just 8 W—comparable to the energy consumption of a single small light bulb.

Thanks to its innovative housing, the noise level of the hood can be reduced by up to **6 dB**. What does this mean in practice? Among other things, it won't interfere with conversations—an important advantage that has become our standard.

This modern technology, enclosed within the motor, delivers outstanding performance:

noise level: from **36 dB** | capacity: up to **900 m³/h**

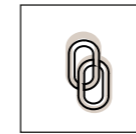

Cook Assist

Automatic synchronization between the induction hob and the cooker hood ensures a more convenient cooking experience. The hood adjusts its extraction power **in real time to match the hob settings**, efficiently removing steam and odors throughout the entire cooking process.

For added flexibility, the hob's touch control panel allows manual adjustment of hood lighting and fan speed whenever required. Cooker hoods and induction hobs connect seamlessly for **smooth, coordinated operation**.

**Our hobs use a wireless communication protocol.*



Automatic mode, the hob manages the hood's power and lighting in automated mode

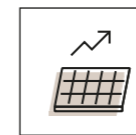

Adapt Flow

redefines the efficiency and noise level of a hood operating with carbon filters—without reducing its performance. It is the **first solution** on the market that perfectly adjusts the hood's operating parameters in recirculation mode.

With Adapt Flow, the device's performance in recirculation mode can be **increased up to 30%**. Switching between modes is intuitive and can be done with a single, simple gesture.

The hood automatically remembers the Adapt Flow setting after restarting, and the function can be easily deactivated if needed. Adapt Flow also ensures excellent performance when ventilation ducting must be reduced, adapting seamlessly to any situation.

Power Level	Recirculation Mode (m ³ /h)	Adapt Flow Mode (m ³ /h)	Performance Gain
I	105	140	+33%
II	170	225	+32%
III	303	325	+7%
IV (Boost)	563	563	Peak Capacity

Please note: Final test values may vary slightly based on specific product design and form factors.

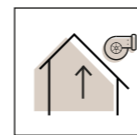

Silence kitchen – OutVent

Silence in the kitchen starts with smart engineering.

The **OutVent system** moves the source of noise outside the cooking area by connecting the hood to an external motor.

Our solution offers full flexibility. It can be integrated not only with dedicated units, but also with external motors from other manufacturers.

One device. Multiple installation possibilities.

Designed to adapt to different architectural and technical requirements.

3 in 1. One platform. Multiple scenarios.

The result is high efficiency and a noticeable reduction of noise, without limiting design possibilities.

OutVent motor

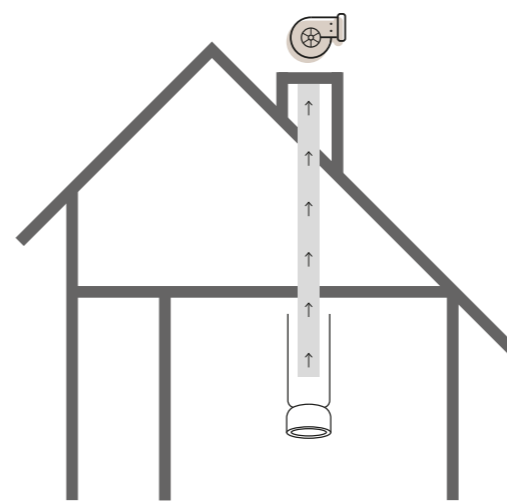

ROOF-MOUNTED MOTOR

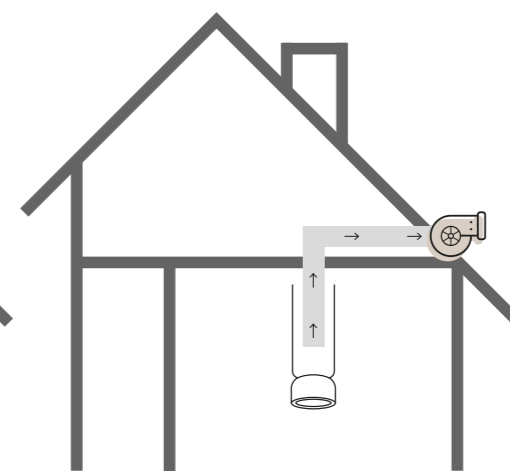

WALL-MOUNTED
EXTERNAL MOTOR

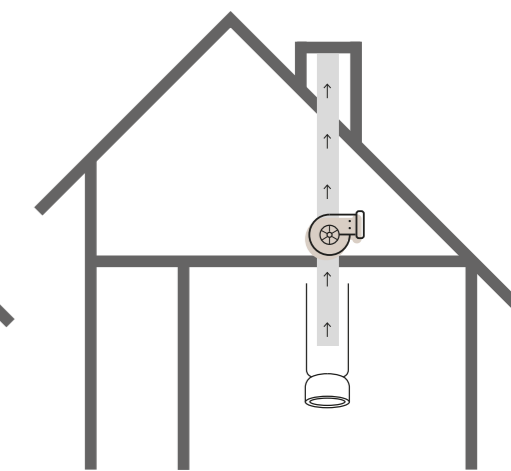

ATTIC-MOUNTED MOTOR



SpaceMax Joker

Designed to protect kitchen furniture and **maximize usable space**. The proprietary air duct system ensures **safe removal of humid air**, even in recirculation mode. It helps **prevent moisture build-up inside the cabinet** while maintaining high performance. Its compact, rectangular design **optimizes the interior layout**, creating **significantly more usable space** without compromising functionality. Fully adaptable, it integrates easily into different cabinet dimensions.

Key features:

- **Moisture protection**, even in recirculation mode.
- **100% stainless steel**. Hygienic and durable.
- **Up to 80% more space** inside the cabinet.





Matte surface

Based on advanced **matte ceramic glass technology**, the surface combines durability with everyday practicality.







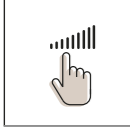

The **low-porosity structure** reduces fingerprints and dirt, keeping the cooktop clean with minimal effort. The **matte finish reduces reflections**, improving visibility and user comfort.

Key features:

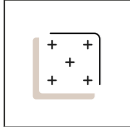

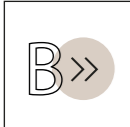
- **Anti-fingerprint surface.**
- **Reduced reflections.**
- **Scratch and chemical resistance.**
- **Easy cleaning.**
- **Long-lasting appearance.**

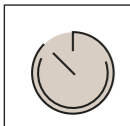

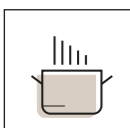
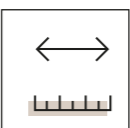
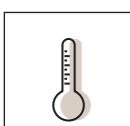
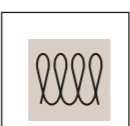
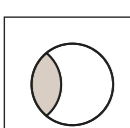
Icon legend

Induction hob technology

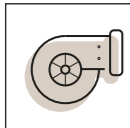

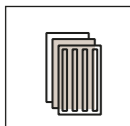
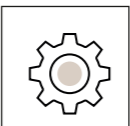

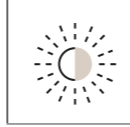
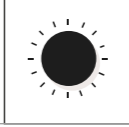
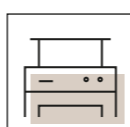
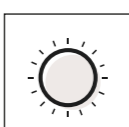
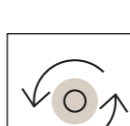
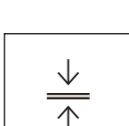
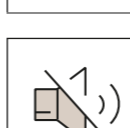
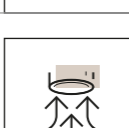
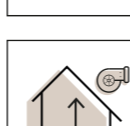
	Slider Get full control of your cooktop with a convenient slider that allows you to easily adjust the cooking fields. It's the way to cook at the touch of a finger.		Large cooking zones (220 × 185 mm) – provide greater flexibility for larger cookware, ensuring even heat distribution and enhanced cooking comfort and enhanced cooking comfort.
	5 Zone hob – plate means even more room for new culinary ideas. Let nothing limit your culinary enthusiasm anymore!		Sliding glass panel – enhances the hood's ability to effectively capture cooking vapors.
	Boost – This function allows you to increase the power to maximum with a single button, reducing cooking time to a minimum.		The matte surface – with reduced porosity effectively minimizes the visibility of smudges, fingerprints, and dirt, allowing the cooktop to maintain a clean and refined appearance for longer.
	Timer – Set the cooking time for each cooking zone individually.		Flush installation with the countertop – The cooktop integrates seamlessly into the countertop.
	Pan Detection – The system automatically detects the pan and activates the heating zones.		Designed for smaller kitchens. Fits perfectly into 60 cm cabinets while delivering full performance.
	Cooking Programs – Quickly and conveniently adjust the temperature to suit your needs.		Automatic hood operation – The range hood's power, on/off, and extraction strength are controlled automatically. You can switch to manual mode at any time.
	Two Bridge Zones – The induction cooktop is equipped with a function that combines cooking zones, allowing for even heating of large or irregularly shaped pots.		

Hood technology

	External OUT motor connection option – allows the motor to be installed outside the hood, ensuring ultra-quiet operation and maximum acoustic comfort inside the kitchen.		Drip Control – An innovative system designed for easy collection and removal of spilled liquids.
	Baffle Filter – Professional-grade filters, commonly used in commercial kitchens, enhance the capture of moisture and grease.		Automatic Hood Operation – The hood automatically adapts to cooking intensity, removing steam, smoke, and odors efficiently. Making your kitchen cleaner and more comfortable.

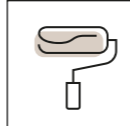
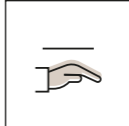
	LED Warm2Cold Lighting – Adjustable lighting color from warm (2900K) to cool (6000K) and with three brightness levels.		Panel Lighting – Large light panel that illuminates the entire kitchen workspace.
	50 cm extendable Hood – Extends up to 50 cm, making it easier to use with large pots and pans.		Perimeter Lighting – Decorative LED lighting around the hood's edges with Warm2Cold functionality.
	Optional Motor Kit – The optional motor kit allows you to conveniently reposition the motor up to 8 meters away to a location of your choice.		Ceiling Installation – Can be installed in suspended ceilings with a height of as little as 20 cm.
	BLDC Motor – Ensures quiet operation and energy efficiency (8W power consumption).		Perimeter Extraction – Air suction technology that pulls air efficiently from across the entire surface of the hood for optimal airflow.
	OutVent – OutVent models is compatible with external motors, allowing flexible installation while ensuring quiet, high-performance operation tailored to your kitchen.		Remote control – allows you to turn the extractor on and off, adjust the fan speed, and change the light colour temperature, ensuring full control and convenience.
	Precise control – via soft-touch buttons, remote control, or directly from the induction hob.		

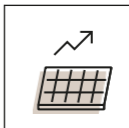
Signature feature

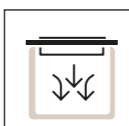
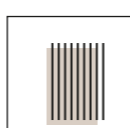
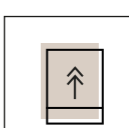
	Anti-Fingerprint Coating – A smooth, satin-finished surface that resists smudges and fingerprints.		GestureControl – Hands-free control of the cooker hood's power and lighting using simple hand gestures.
	Internationally awarded design – Our products have been noticed and appreciated by international design experts, confirming their quality, functionality, and consistency of form.		AdaptFlow – Smart software that optimizes airflow in absorption mode for better colours: performance and efficiency.
	Cook Assist – Automatic synchronization between the cooker hood and the induction cooktop for seamless operation.		SpaceMax Wizard – Compatible with the special SpaceMax Wizard air duct.
	Ribbed Surface – Unique, precision-engineered texture for a distinctive look.		SpaceMax Joker – Innovative solution that increases storage space in upper kitchen cabinets by up to 80%.

02

**EXTRACTOR
HOBS**







extractor hobs

A LUXURIOUS FUSION OF TECHNOLOGY
AND DESIGN IN ONE PERFECTLY INTEGRATED FORM.

Wizard 2.0

extractor hob

Wizard 2.0 is an **integrated extractor with an induction hob** that brings a **new level of quality and unmatched functionality** to your kitchen. Designed for those who value **modern technology** as much as **exceptional design**.

	Drip Control
	Automatic extractor operation
	Two Bridge zones
	Cooking programs
	SpaceMax Wizard system











Wizard 2.0

extractor hob

Basic specifications

Hood type	Integrated with induction hob
Dimensions (H × W × D)	232.5 × 830 × 515 mm
Airflow (min-max / boost)	180-510 (730) m ³ /h
Noise level (boost)	36-61 (68) dB
Finish	Glossy black
Energy efficiency class	A+
Maximum power	7,560 W
Motor power	160 W
Charcoal filter (type)	Long Life Wizard 2.0 grease filter + filter holder
Grease filter	4
Charcoal filter included	Yes
Carbon filter installation method	Mounted on the grease filter
Air outlet diameter	220 × 90 mm
Control color	White
Filtration	Four-stage system
Spill management system	Triple system
Drip Control	Yes
Bridge zones	Yes - 2x
Automatic cooking programs	Yes
Automatic extractor operation	Yes
Metal construction	Yes
Timer	Yes
Boost	Yes
Flush installation	Yes
SpaceMax system compatibility	Yes
Net weight	21.2 kg

Technologies

								
Drip Control	Automatic extractor operation	Two Bridge zones	Boost	Timer	Cooking programs	SpaceMax Wizard	Flush installation	Pan detection function

Technical drawing

(WYLOT W DÓŁ)

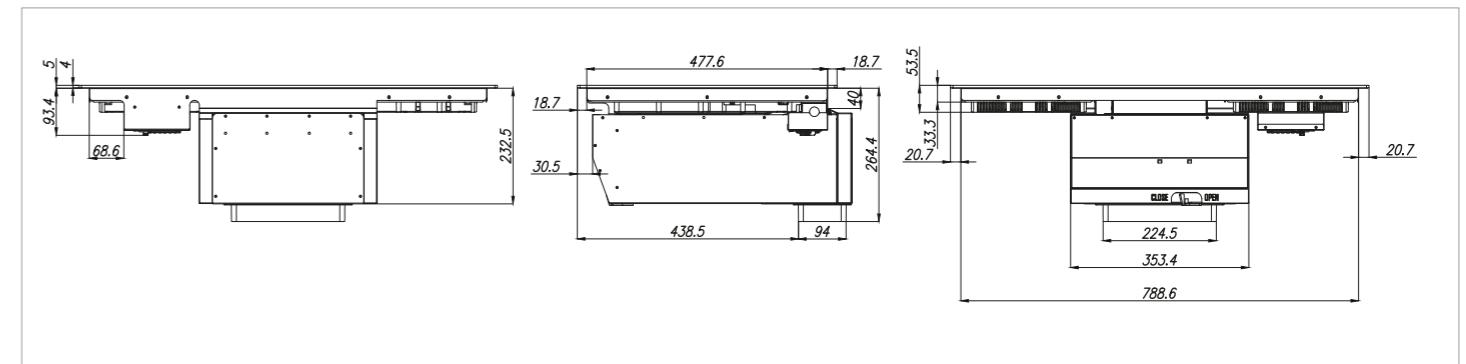



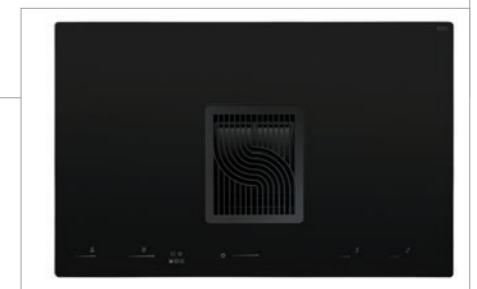
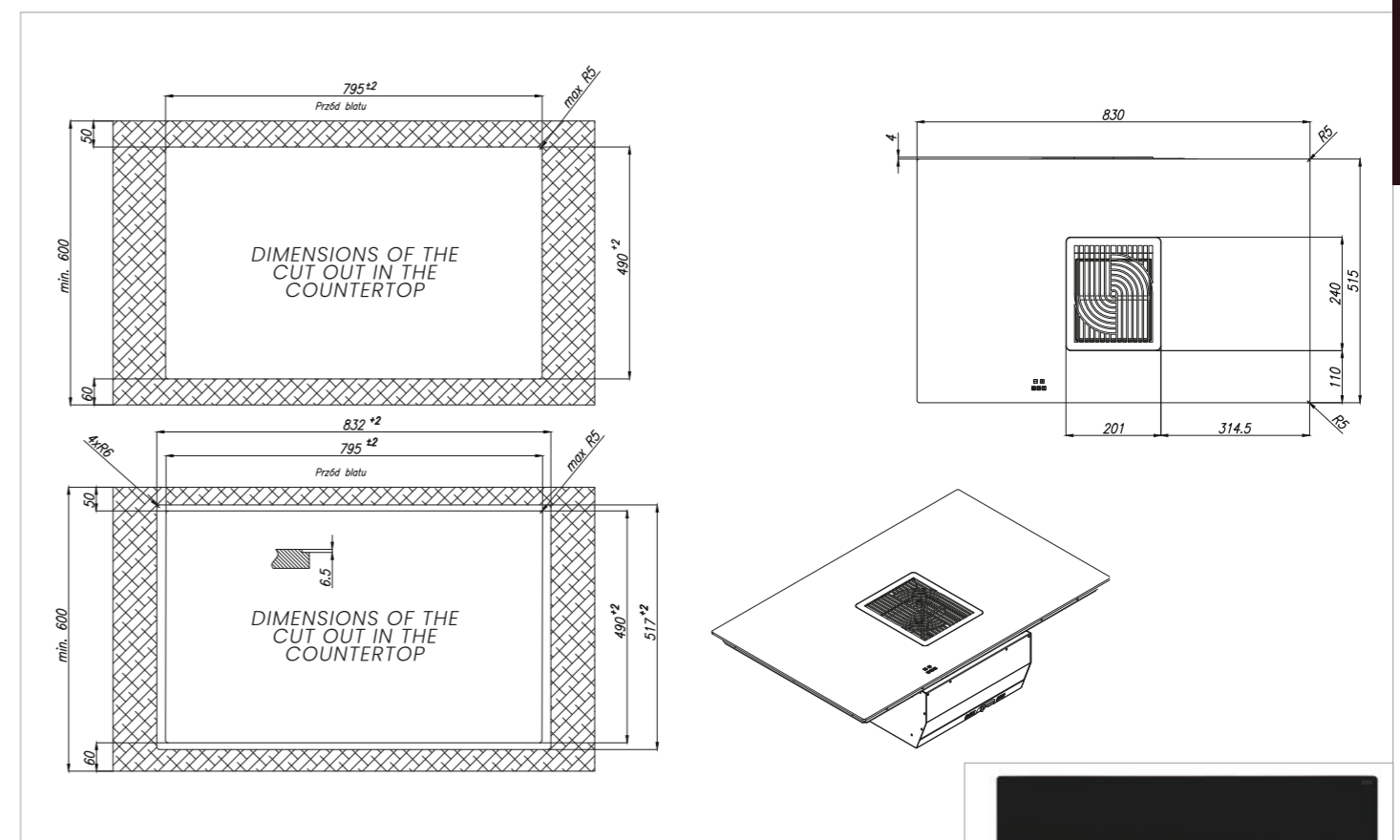
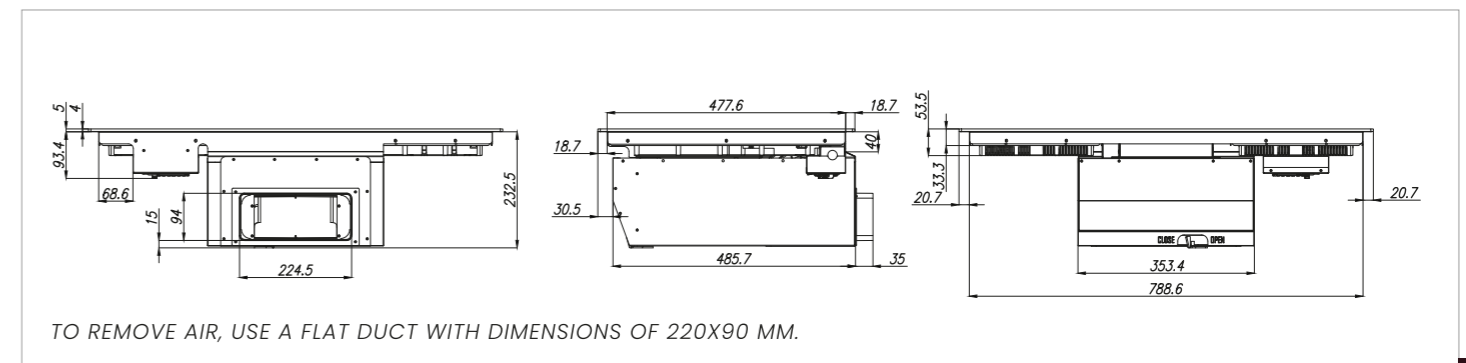



(REAR OUTLET)



WizardMatte 83

extractor hob

This **advanced 2-in-1 system** features a **centrally positioned air inlet seamlessly flush with the matte glass surface**. The **matte coating** makes **grease particles and fingerprints nearly invisible**, significantly improving ease of cleaning in the cooking area. A **powerful turbine hidden the cabinet** operates at a **top energy efficiency class**, capturing vapours **instantly at the source** before they spread throughout the room.

	Matte surface
	Drip Control
	Automatic extractor operation
	Two Bridge zones
	Cooking programs
	SpaceMax Wizard system











WizardMatte 83

extractor hob

Basic specifications

Hood type	Integrated with induction hob
Dimensions (H × W × D)	231 × 830 × 515 mm
Airflow (min-max / boost)	140-330 (580) m ³ /h
Noise level (boost)	38-57 (67) dB
Finish	Matte black
Energy efficiency class	A
Maximum power	7,560 W
Motor power	160 W
Charcoal filter (type)	Long Life Wizard Matte 83 grease filter + filter holder
Grease filter	4
Charcoal filter included	Yes
Carbon filter installation method	Mounted on the grease filter
Air outlet diameter	220 × 90 mm
Control color	Red
Filtration	Four-stage system
Spill management system	Dual system
Drip Control	No
Bridge zones	Yes - 2x
Automatic cooking programs	No
Automatic extractor operation	Yes
Metal construction	Yes
Timer	Yes
Boost	Yes - 4x
Flush installation	Yes
SpaceMax system compatibility	Yes
Net weight	20.4 kg

Technologies

								
Sliding glass extractor cover	Automatic extractor operation	Two Bridge zones	Boost	Timer	SpaceMax Wizard	Flush installation	Matte surface	Pan detection function

Technical drawing

(OUTLET DOWN)

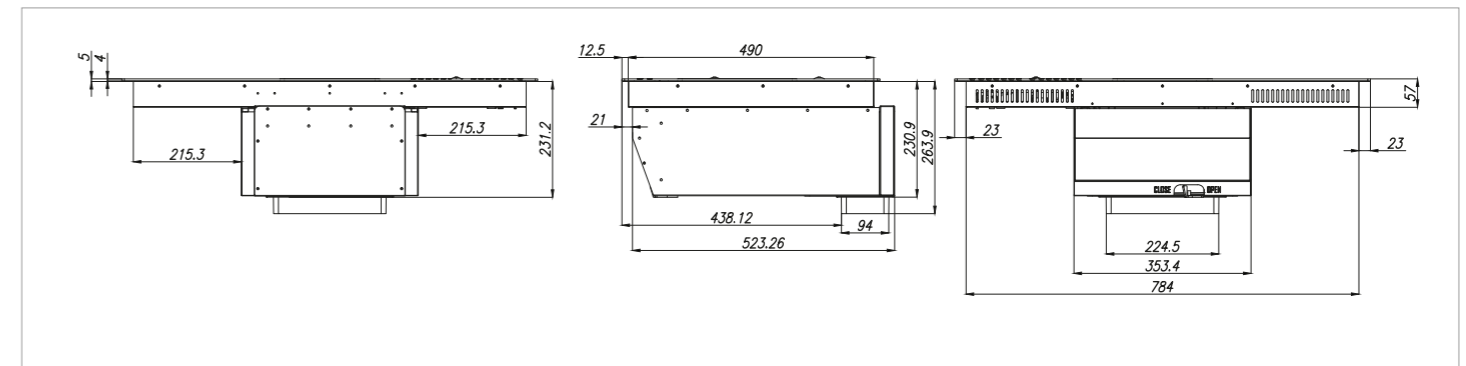



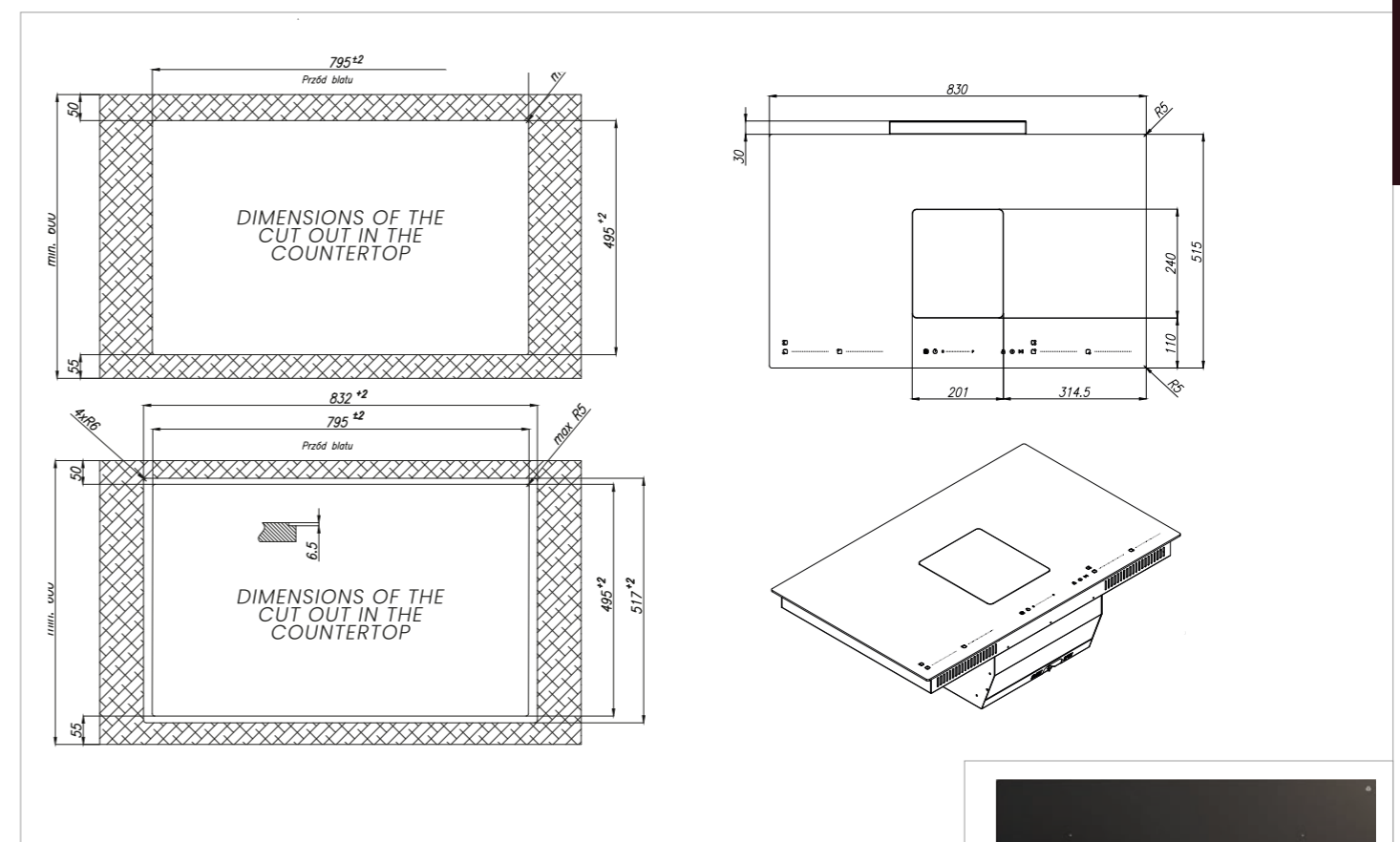
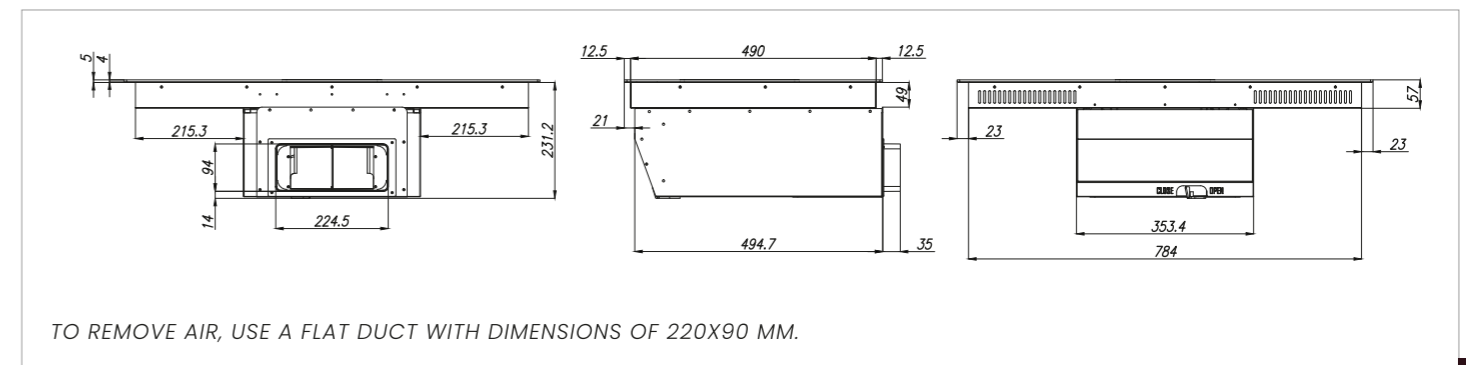

(REAR OUTLET)



Wizard One

extractor hob

This **compact solution** is perfect for those seeking **space-saving design without compromising premium aesthetics**. The appliance integrates the **extractor and hob functions in one unit**, eliminating the need for a traditional overhead hood. The **Drip Control system** ensures **easy cleaning in case of spills**, making everyday cooking **safe and exceptionally comfortable**.

	Drip Control
	Automatic extractor operation
	Two Bridge zones
	Cooking programs
	SpaceMax Wizard system











Wizard One

extractor hob

Basic specifications

Hood type	Integrated with induction hob
Dimensions (H × W × D)	231 × 830 × 515 mm
Airflow (min-max / boost)	170-410 (655) m ³ /h
Noise level (boost)	38-59 (68) dB
Finish	Glossy black
Energy efficiency class	A+
Maximum power	7,560 W
Motor power	160 W
Charcoal filter (type)	Long Life Wizard One grease filter + filter holder
Grease filter	2
Charcoal filter included	Yes
Carbon filter installation method	Mounted on the grease filter
Air outlet diameter	220 × 90 mm
Control color	Red
Filtration	Dual system
Spill management system	Dual system
Drip Control	Yes
Bridge zones	Yes - 2x
Automatic cooking programs	No
Automatic extractor operation	Yes
Metal construction	Yes
Timer	Yes
Boost	Yes - 4x
Flush installation	Yes
SpaceMax system compatibility	Yes
Net weight	20.4 kg

Technologies

							
Drip Control	Automatic extractor operation	Two Bridge zones	Boost	Timer	SpaceMax Wizard	Flush installation	Pan detection function

Technical drawing

(OUTLET DOWN)

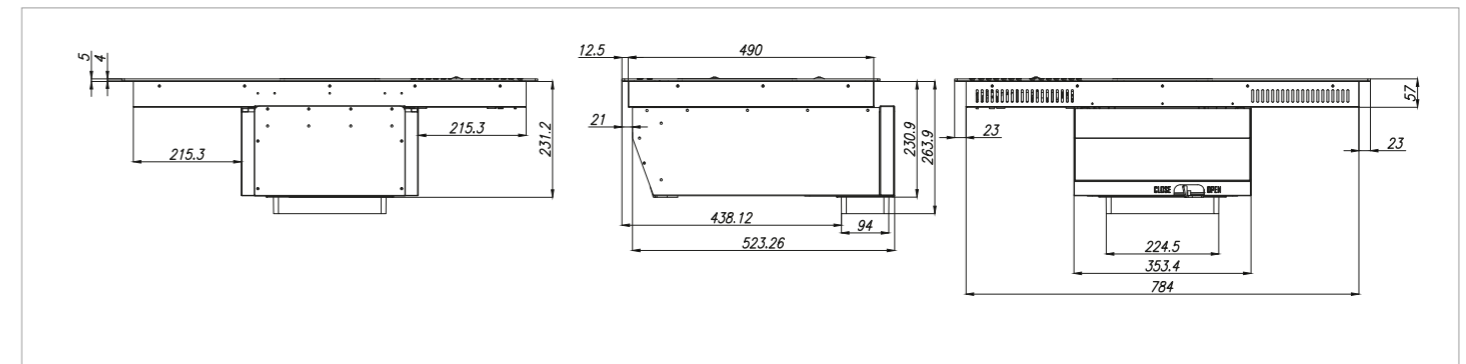



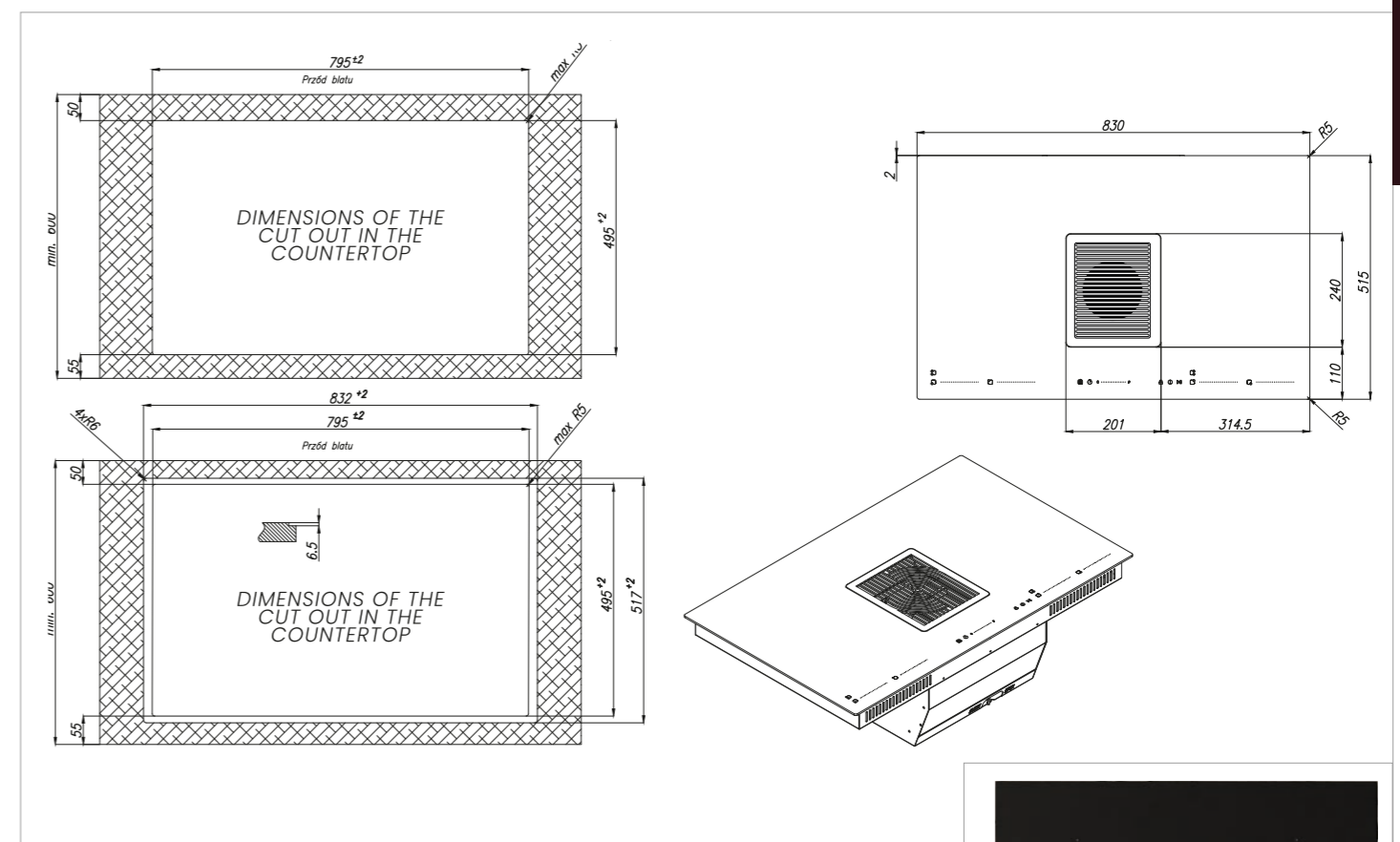
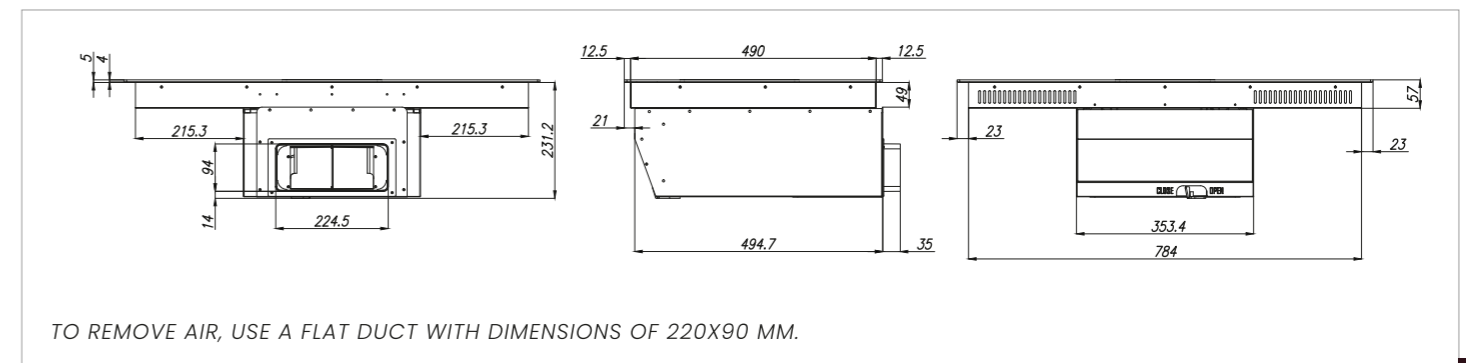



(REAR OUTLET)



WizardMatte Slim

extractor hob

It is an **ideal solution for smaller kitchens**, offering the **full functionality of a 2-in-1 system within a standard 60 cm cabinet width**. The **matte ceramic glass finish** effectively conceals **fingerprints and micro-scratches**, maintaining a **luxurious appearance even with intensive use**. Thanks to a **compact motor with a height of just 23 cm**, the system allows for the **installation of drawers directly beneath the hob**, without compromising valuable storage space.

	Matte surface
	Drip Control
	Automatic extractor operation
	Two Bridge zones
	Cooking programs
	SpaceMax Wizard system













WizardMatte Slim

extractor hob

Basic specifications

Hood type	Integrated with induction hob
Dimensions (H × W × D)	60 cm – 241 × 600 × 515 mm 72 cm – 241 × 720 × 515 mm
Airflow (min-max / boost)	145–345 (550) m ³ /h
Noise level (boost)	36–59 (69) dB
Finish	Matte black
Energy efficiency class	A
Maximum power	7,360 W
Motor power	160 W
Charcoal filter (type)	Long Life Wizard Slim grease filter + filter holder
Grease filter	2
Charcoal filter included	Yes
Carbon filter installation method	Mounted on the grease filter
Air outlet diameter	220 × 90 mm
Control color	Red
Filtration	Dual system
Spill management system	Single system
Drip Control	No
Bridge zones	Yes – 2x
Automatic cooking programs	No
Automatic extractor operation	Yes
Metal construction	Yes
Timer	Yes
Boost	Yes – 4x
Flush installation	Yes
SpaceMax system compatibility	Yes
Net weight	60 cm – 15.5 kg 72 cm – 16.2 kg

Technologies

									
Matte surface	Reduced hob width	Automatic extractor operation	Two Bridge zones	Boost	Keep warm function	SpaceMax Wizard	Flush installation	Boost	Cooking zone size

Technical drawing

(OUTLET DOWN)

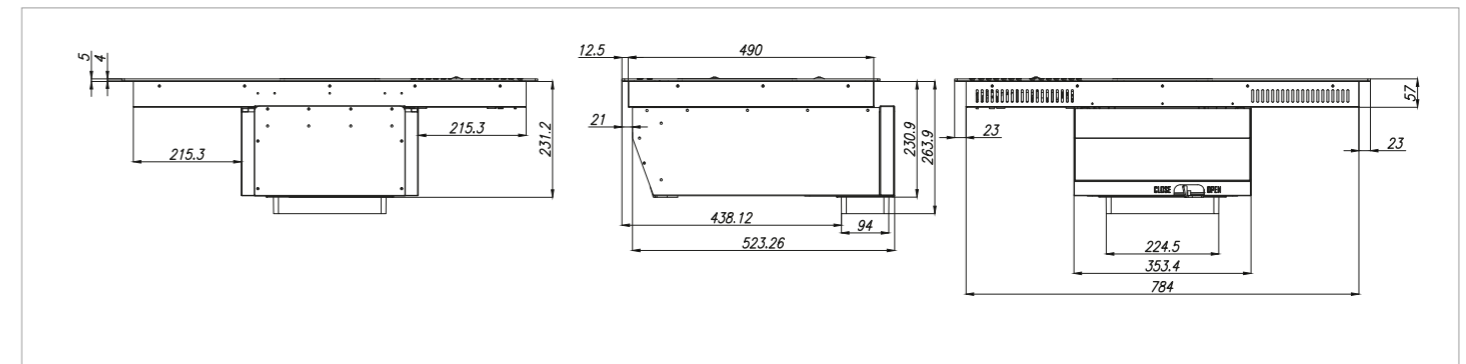



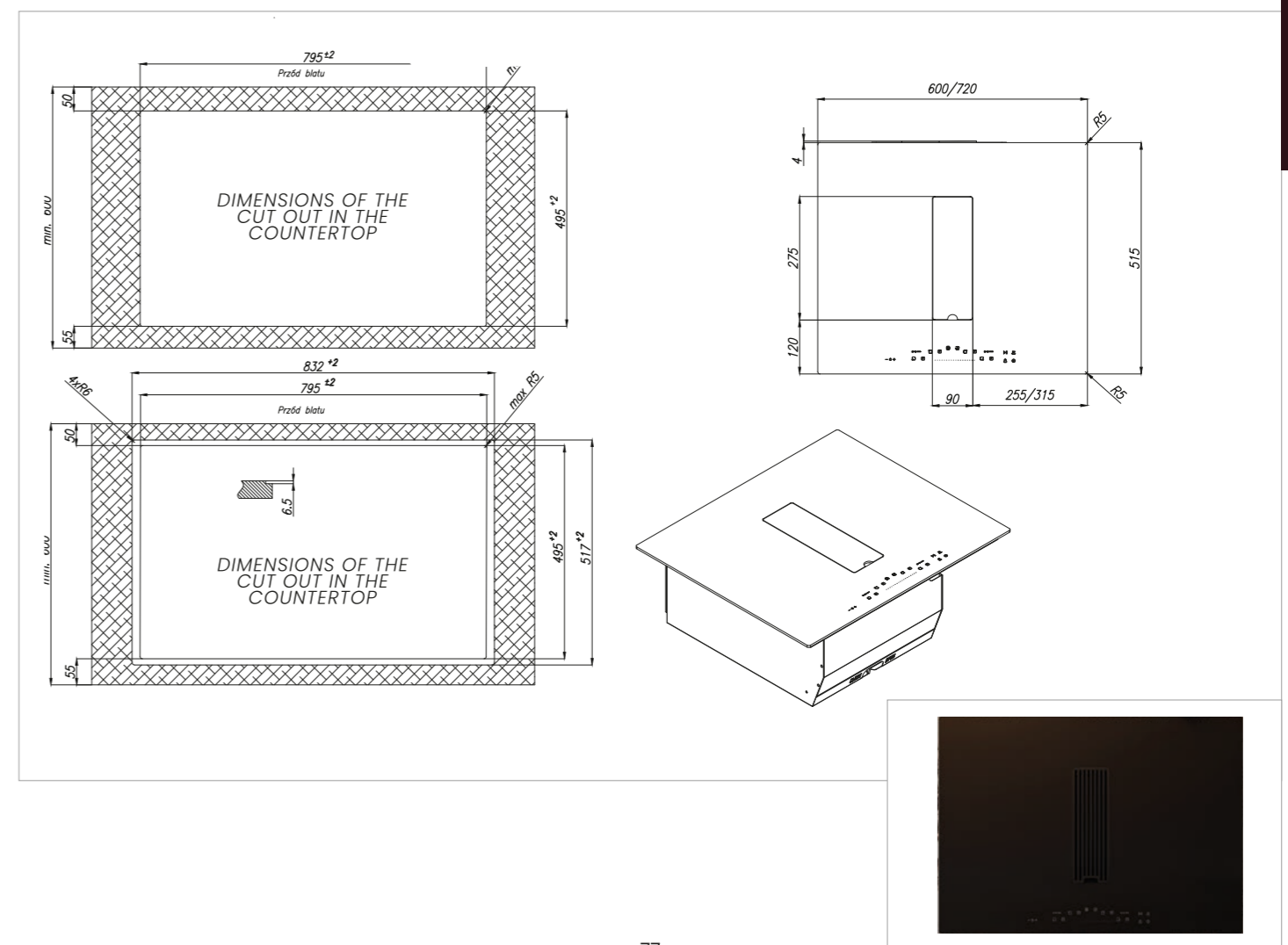
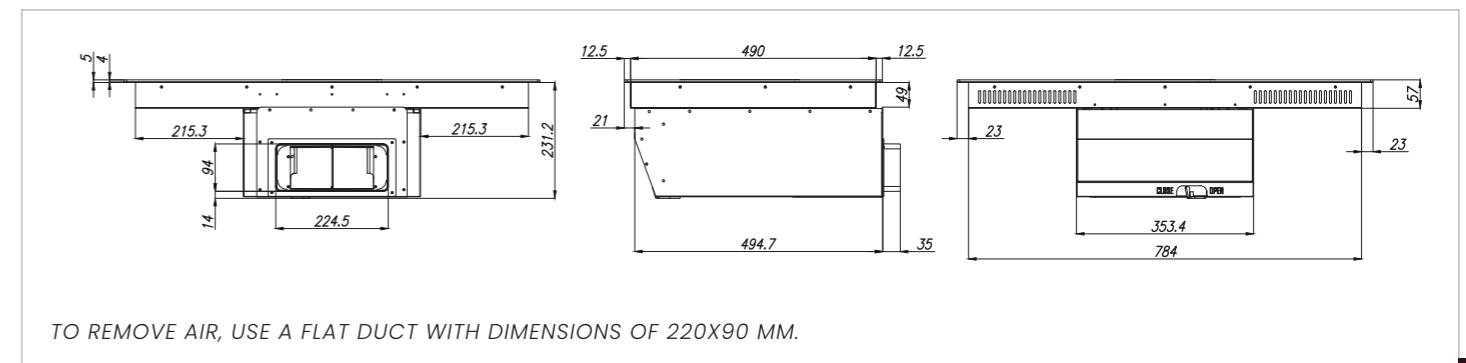

(REAR OUTLET)



Wizard Slim

extractor hob

It features an **ultra-slim motor design**, allowing for **maximum space inside base cabinets**. Despite its compact form, the extractor delivers **high-performance vapour extraction directly at the source**, preventing it from spreading throughout the home. It is an **ideal choice for modern open-plan kitchens**, where **every centimetre counts and visual minimalism is key**.

	Drip Control
	Automatic extractor operation
	Two Bridge zones
	Cooking programs
	SpaceMax Wizard system



Wizard Slim

extractor hob

Basic specifications

Hood type	Integrated with induction hob
Dimensions (H × W × D)	60 cm – 241 × 600 × 515 mm 72 cm – 241 × 720 × 515 mm
Airflow (min–max / boost)	145–345 (550) m ³ /h
Noise level (boost)	36–59 (69) dB
Finish	Glossy black
Energy efficiency class	A
Maximum power	7,360 W
Motor power	160 W
Charcoal filter (type)	Long Life Wizard Slim grease filter + filter holder
Grease filter	2
Charcoal filter included	Yes
Carbon filter installation method	Mounted on the grease filter
Air outlet diameter	220 × 90 mm
Control color	Red
Filtration	Dual system
Spill management system	Single system
Drip Control	No
Bridge zones	Yes – 2x
Automatic cooking programs	No
Automatic extractor operation	Yes
Metal construction	Yes
Timer	Yes
Boost	Yes – 4x
Flush installation	Yes
SpaceMax system compatibility	Yes
Net weight	60 cm – 15.5 kg 72 cm – 16.2 kg

Technologies

Reduced hob width	Automatic extractor operation	Two Bridge zones	Boost	Keep warm function	SpaceMax Wizard	Flush installation	Boost	Cooking zone size

Technical drawing

(OUTLET DOWN)

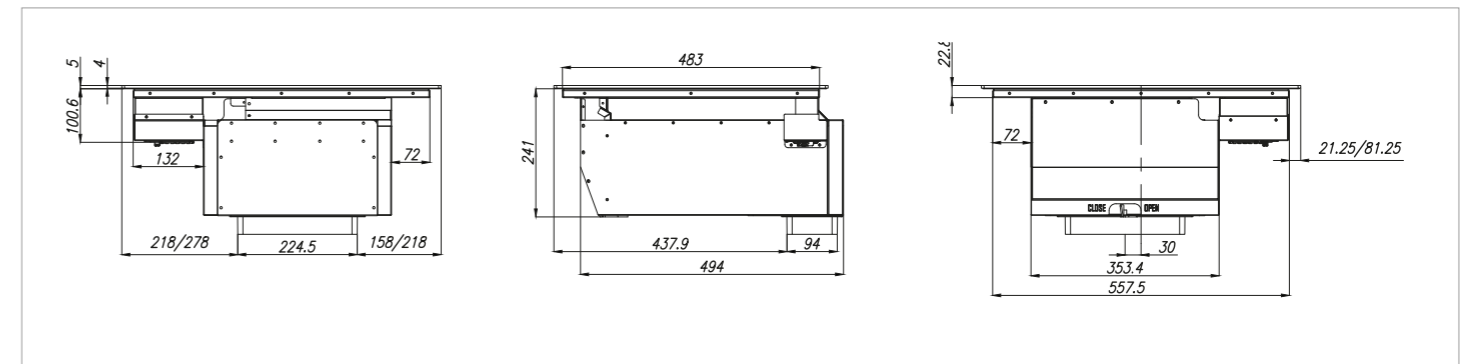

(REAR OUTLET)

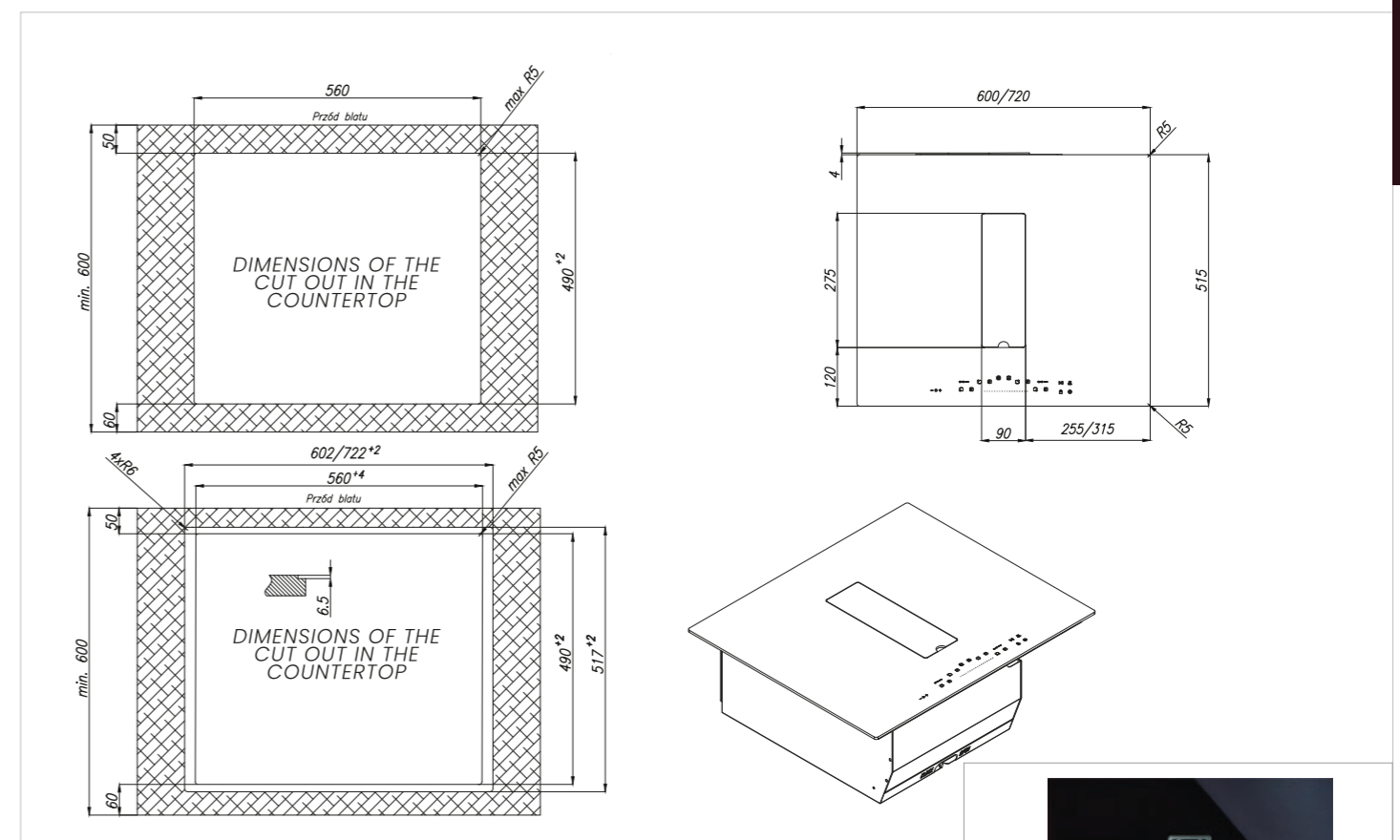
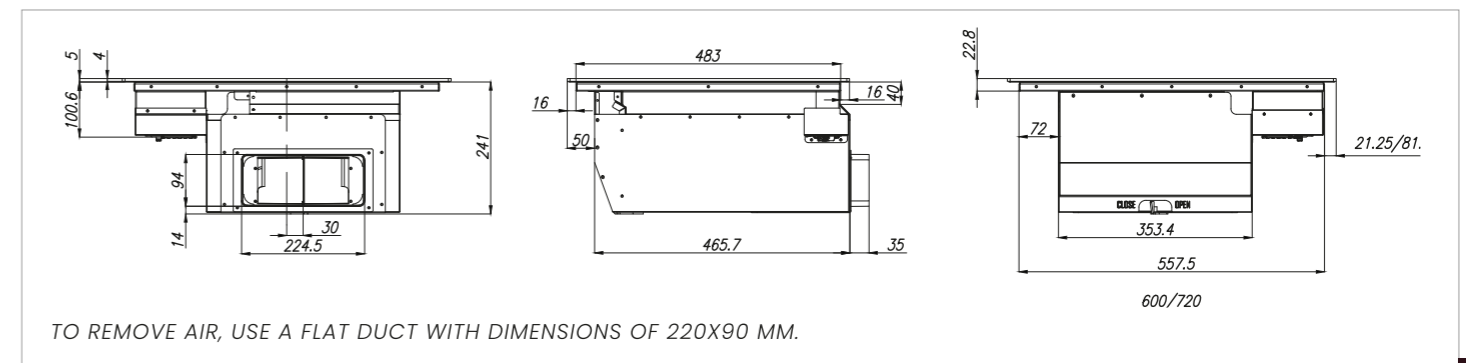

03

**WALL
MOUNTED
HOODS**



wall mounted hood

A HARMONIOUS BLEND OF REFINED DESIGN AND HIGH PERFORMANCE,
CREATED WITH YOUR KITCHEN IN MIND.

ICON







MONO

MONO

wall mounted hood

It is a **celebration of geometric minimalism**, centred around a **slim oval form**. Its **raw yet elegant design** fits perfectly into **loft and industrial interiors**, creating a **strong visual statement**. With **high performance** and **precise control**, Mono is not only a **design feature**, but above all a **professional air purification solution**.

	Proprietary fluted surface
	Warm2Cold lighting
	GestureControl
	BLDC motor
	Cook Assist

COLOR OPTIONS



TEXTURE, UP CLOSE

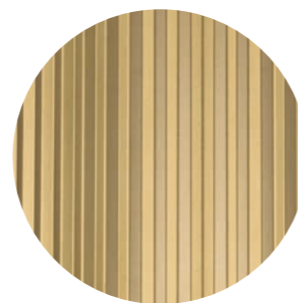

AWARDS













MONO

wall mounted hood

Basic specifications

Hood type	Wall-mounted
Dimensions (H x W x D)	60 cm - 492 x 599 x 290 mm 80 cm - 562 x 799 x 290 mm
Airflow (min-max / boost)	60 cm - 200-400 (650) m ³ /h 80 cm - 200-475 (730) m ³ /h
Noise level (boost)	60 cm - 40-58 (69) dB 80 cm - 42-57 (68) dB
Energy efficiency class	60 cm- A+, 80 cm - A++
Ventilation type	Extraction/Recirculation
Motor power	160 W
Lighting power	60 cm - 5 W, 80 cm - 4 W
Lighting functions	Warm2Cold LED; adjustable intensity and colour temperature
Charcoal filter (type)	Long Life M/S
Charcoal filter included	No
Minimum distance from electric hob	45 cm
Minimum distance from gas hob	65 cm
Air outlet diameter	220 x 90 mm
Control type	Gesture control and remote control
Speed levels	4
Alternative control	Soft-touch buttons, control via induction hob
Rotatable motor	No
Hob-to-hood communication (Cook Assist)	Yes
External motor connection option (Outvent)	Yes
Net weight	60 cm - 12,7 kg, 80 cm - 13,6 kg
Adapt Flow technology	Yes

Technologies

									
Warm2ColdLED	GestureControl	Remote control	BLDC motor	Anti Fingerprint	Fluted surface	Flexible installation	Cook Assist	Perimeter extraction	Adapt Flow

Technical drawing

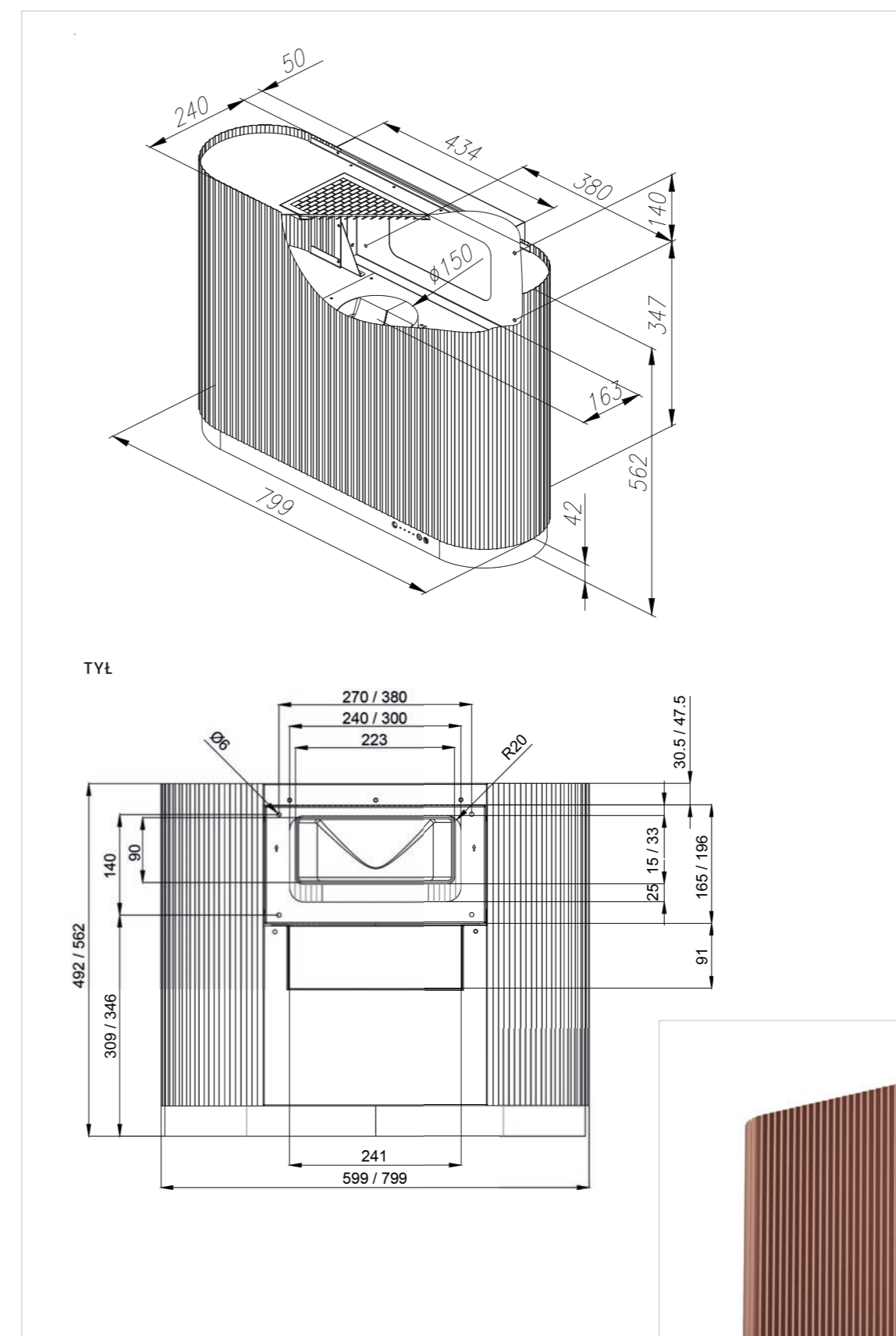







SIMPLE

SIMPLE

wall mounted hood

As the name suggests, it focuses on **purity of form** and **functionality free from unnecessary ornamentation**. It is a **timeless classic** that, thanks to its **simple construction and high-quality steel**, fits perfectly into any kitchen, regardless of trends. **Solid craftsmanship** goes hand in hand with **reliability**, ensuring **effective odour extraction for years to come**.

	Anti Fingerprint
	Warm2Cold lighting
	GestureControl
	BLDC motor
	Cook Assist

COLOR OPTIONS



AWARDS











SIMPLE

wall mounted hood

Basic specifications

Hood type	Wall-mounted
Dimensions (H x W x D)	590 x 598 x 290 mm
Airflow (min-max / boost)	200-400 (650) m ³ /h
Noise level (boost)	40-58(69) dB
Energy efficiency class	A+
Ventilation type	Extraction/Recirculation
Motor power	160 W
Lighting power	5 W
Lighting functions	Warm2Cold LED; adjustable intensity and colour temperature
Charcoal filter (type)	Long Life M/S
Charcoal filter included	No
Minimum distance from electric hob	45 cm
Minimum distance from gas hob	65 cm
Air outlet diameter	220 x 90 mm
Control type	Gesture control and remote control
Speed levels	4
Alternative control	Soft-touch buttons, control via induction hob
Rotatable motor	No
Hob-to-hood communication (Cook Assist)	Yes
External motor connection option (Outvent)	Yes
Net weight	15.3 kg
Adapt Flow technology	Yes

Technologies

								
Warm2ColdLED	GestureControl	Remote control	BLDC motor	Anti Fingerprint	Flexible installation	Cook Assist	Perimeter extraction	Adapt Flow

Technical drawing

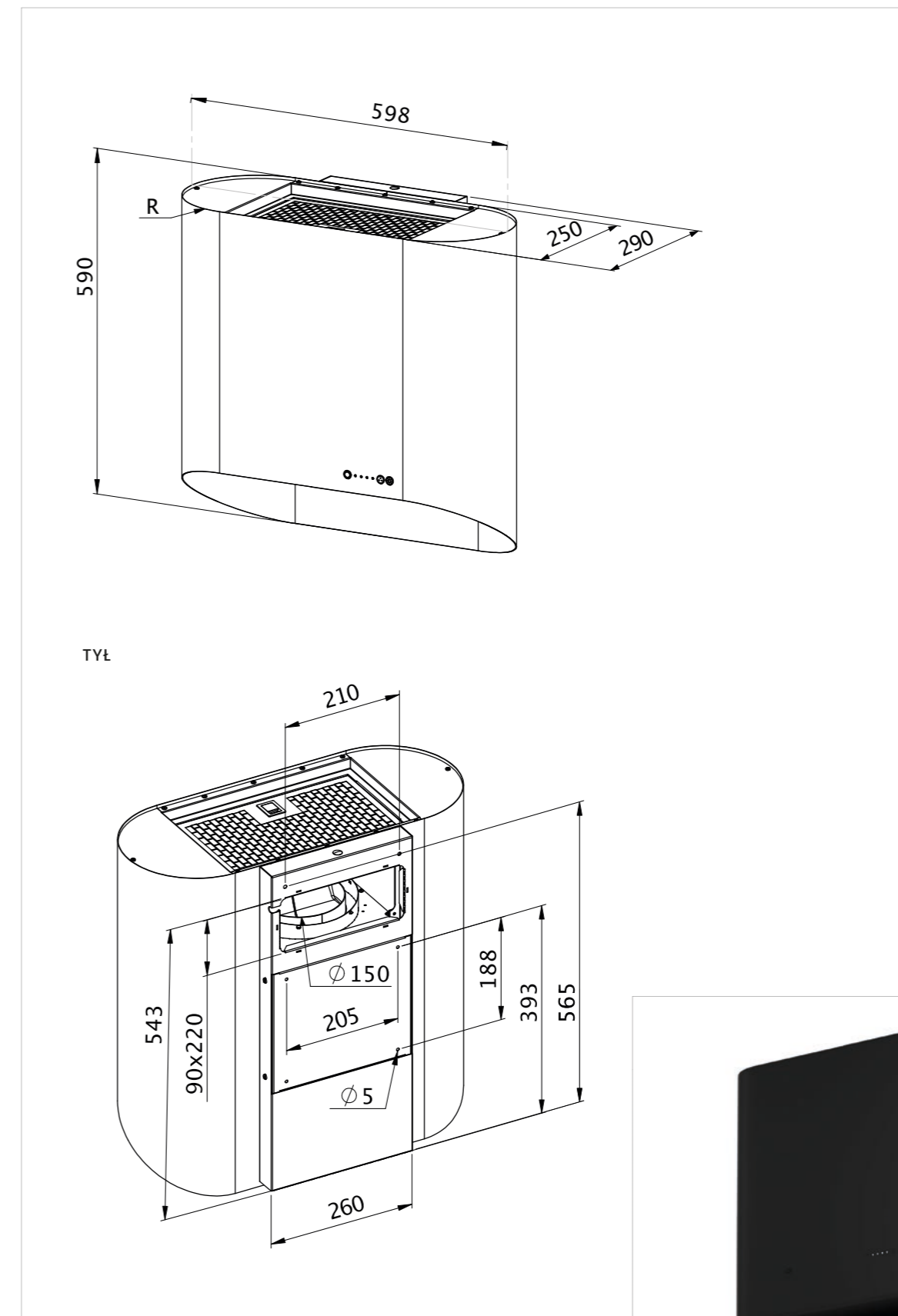



ICON

wall mounted hood

It is a **striking combination of minimalist form and advanced technology**, becoming the **central focal point of a modern kitchen**. Its **unique design**, reminiscent of a **suspended artwork or contemporary sculpture**, conceals **high performance** and **intuitive gesture control**. With **meticulous attention to detail** and the use of **premium materials**, this model not only **efficiently purifies the air**, but above all **enhances the prestigious character of the interior**.



	Internationally awarded design
	Warm2Cold lighting
	GestureControl
	BLDC motor
	Cook Assist

COLOR OPTIONS



AWARDS











ICON

wall mounted hood

Basic specifications

Hood type	Wall-mounted
Dimensions (H x W x D)	900 x Ø382 x 402 mm
Airflow (min-max / boost)	150-355 (630) m ³ /h
Noise level (boost)	39-56 (69) dB
Energy efficiency class	A+
Ventilation type	Extraction/Recirculation
Motor power	160 W
Lighting power	8 W
Lighting functions	Warm2Cold LED; adjustable intensity and colour temperature
Charcoal filter (type)	FWK228, Long Life 228
Charcoal filter included	No
Minimum distance from electric hob	45 cm
Minimum distance from gas hob	65 cm
Air outlet diameter	Ø 150
Control type	Gesture control
Speed levels	4
Alternative control	Control via induction hob, remote control
Rotatable motor	No
Hob-to-hood communication (Cook Assist)	Yes
External motor connection option (Outvent)	Yes
Net weight	19 kg
Adapt Flow technology	Yes

Technologies

								
Warm2ColdLED	GestureControl	Remote control	BLDC motor	Anti Fingerprint	Flexible installation	Cook Assist	Perimeter extraction	Adapt Flow

Technical drawing

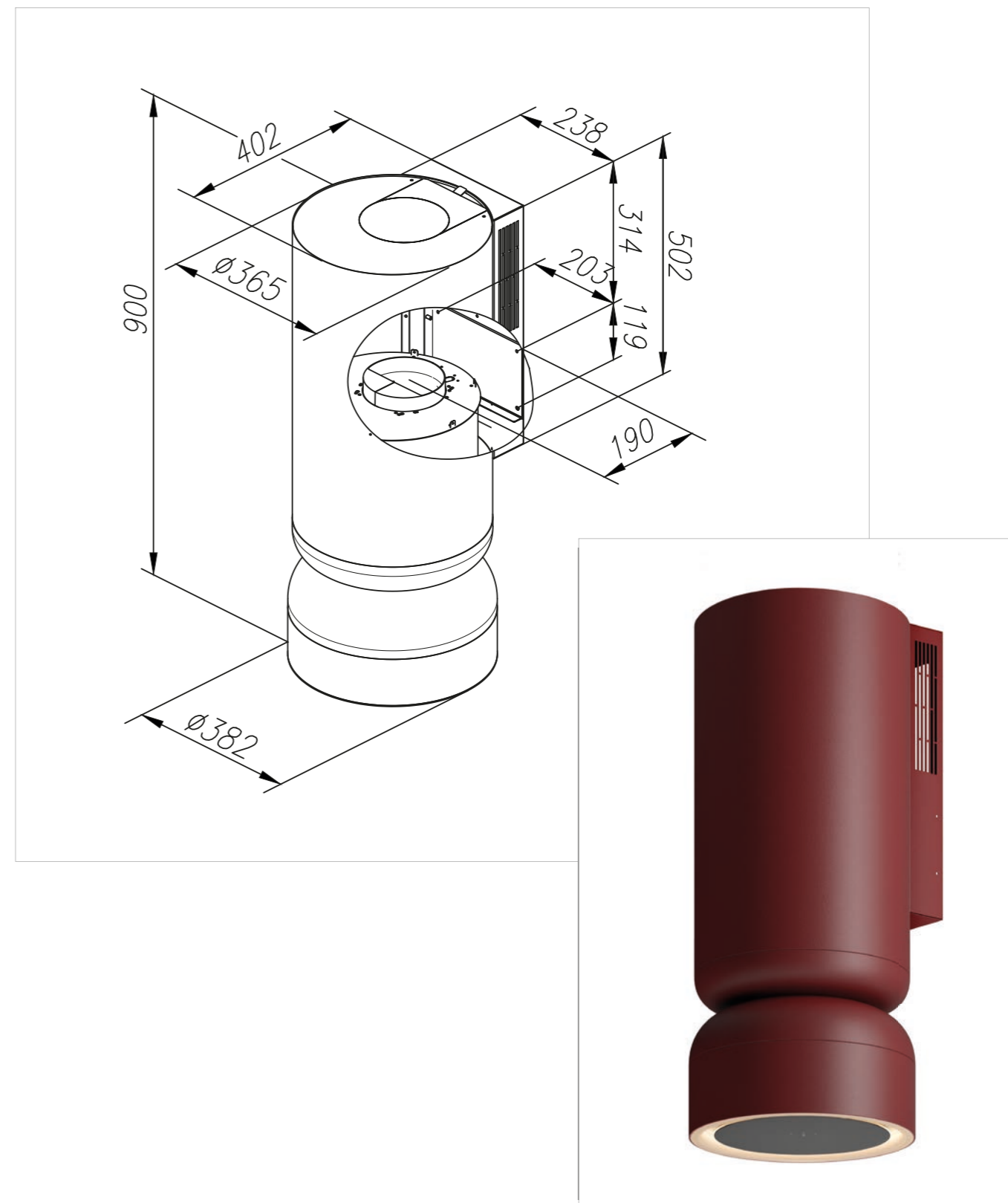



FLUO

FLUO

wall mounted hood

It is a **bold choice for visionary designers**, distinguished by an **extraordinary play of light** and **rich, expressive finishes**. The appliance becomes a **jewel of the interior**, and thanks to **touchless GestureControl technology**, it allows for **full operation without leaving fingerprints on the surface**. This is a model that **redefines the concept of an extractor**, turning it into a **key decorative element of a modern open-plan living space**.



	Internationally awarded design
	Warm2Cold lighting
	GestureControl
	BLDC motor
	Cook Assist

COLOR OPTIONS











FLUO

wall mounted hood

Basic specifications

Hood type	Wall-mounted
Dimensions (H x W x D)	900 x Ø384 x 382 mm
Airflow (min-max / boost)	155-360 (640) m³/h
Noise level (boost)	39-56(69) dB
Energy efficiency class	A+
Ventilation type	Extraction/Recirculation
Motor power	160 W
Lighting power	8 W
Lighting functions	Warm2Cold LED; adjustable intensity and colour temperature
Charcoal filter (type)	FWK228, Long Life 228
Charcoal filter included	No
Minimum distance from electric hob	45 cm
Minimum distance from gas hob	65 cm
Air outlet diameter	Ø 150
Control type	Gesture control
Speed levels	4
Alternative control	Control via induction hob, remote control
Rotatable motor	No
Hob-to-hood communication (Cook Assist)	Yes
External motor connection option (Outvent)	Yes
Net weight	19 kg
Adapt Flow technology	Yes

Technologies

								
Warm2ColdLED	GestureControl	Remote control	BLDC motor	Anti Fingerprint	Flexible installation	Cook Assist	Perimeter extraction	Adapt Flow

Technical drawing

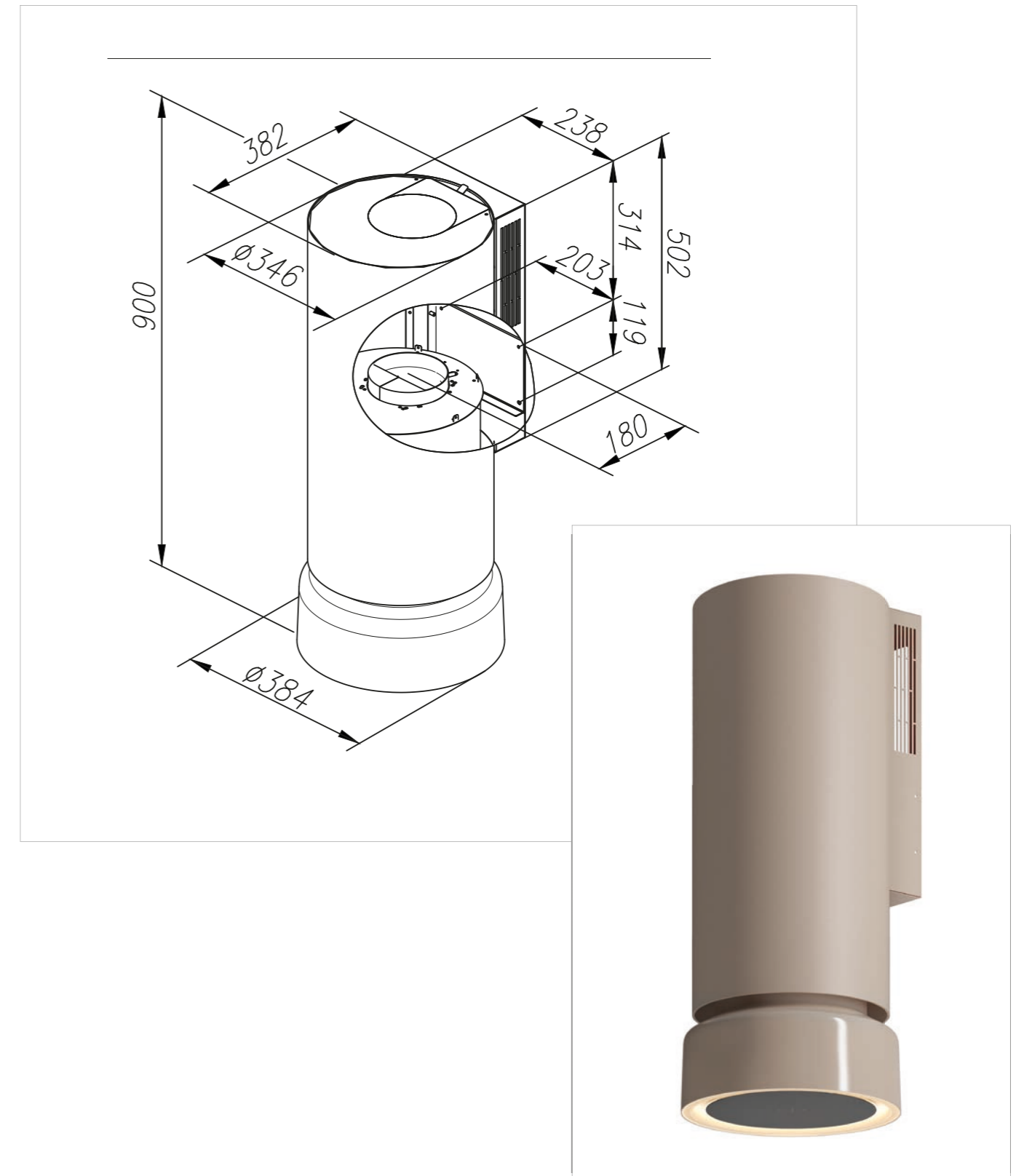







MONOGRAM

MONOGRAM

wall mounted hood

It combines **architectural rawness** with a **distinctive fluted surface detail**, adding **depth and a modern character** to the form. The **vertical grooves** interact with light, creating a **striking three-dimensional effect** that turns the appliance into a **bold decorative feature in any kitchen**. This attention to material texture not only enhances its **aesthetic appeal**, but also emphasizes its **premium, craftsmanship-driven character**.



	Proprietary fluted surface
	Warm2Cold lighting
	GestureControl
	BLDC motor
	Cook Assist

COLOR OPTIONS



TEXTURE, UP CLOSE

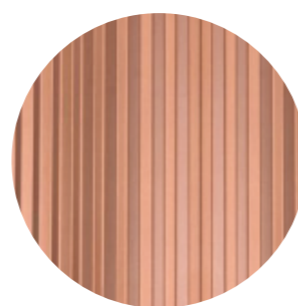











MONOGRAM

wall mounted hood

Basic specifications

Hood type	Wall-mounted
Dimensions (H × W × D)	900 × 382 × 480 mm
Airflow (min-max / boost)	160-370 (670) m ³ /h
Noise level (boost)	39-56 (69) dB
Energy efficiency class	A+
Ventilation type	Extraction/Recirculation
Motor power	160 W
Lighting power	8 W
Lighting functions	Warm2Cold LED; adjustable intensity and colour temperature
Charcoal filter (type)	FWK228, Long Life 228
Charcoal filter included	No
Minimum distance from electric hob	45 cm
Minimum distance from gas hob	65 cm
Air outlet diameter	Ø 150 mm
Control type	Gesture control
Speed levels	4
Alternative control	Control via induction hob, remote control
Rotatable motor	None
Hob-to-hood communication (Cook Assist)	Yes
External motor connection option (Outvent)	Yes
Net weight	19 kg
Adapt Flow technology	Yes

Technologies

									
Warm2ColdLED	GestureControl	Remote control	BLDC motor	Anti Fingerprint	Fluted surface	Flexible installation	Cook Assist	Perimeter extraction	Adapt Flow

Technical drawing

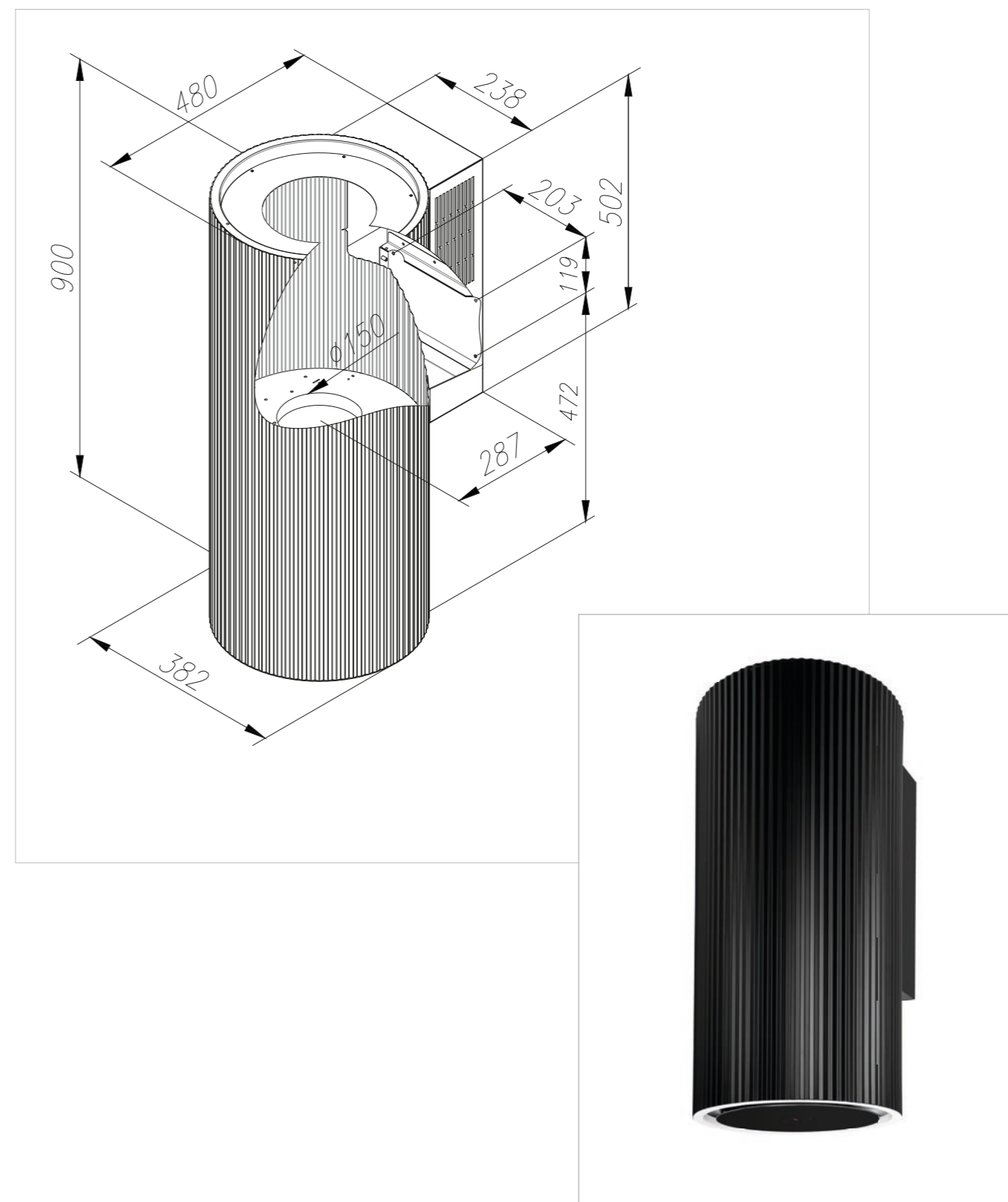







ROTO

ROTO

wall mounted hood

This model **captures attention with its dynamic, rounded form**, softening the sharp lines of modern kitchen cabinetry. It combines the **lightness of contemporary sculpture** with **advanced quiet-operation technology**. Thanks to its **compact dimensions** and **efficient LED lighting**, Roto perfectly illuminates the cooking area, creating a **warm and inviting atmosphere for evening cooking**.



	Proprietary fluted surface
	Warm2Cold lighting
	GestureControl
	BLDC motor
	Cook Assist

COLOR OPTIONS



TEXTURE, UP CLOSE

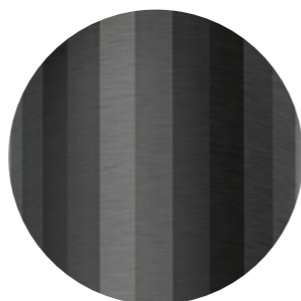











ROTO

wall mounted hood

Basic specifications

Hood type	Wall-mounted
Dimensions (H x W x D)	900 x 382 x 480 mm
Airflow (min-max / boost)	160-370 (670) m ³ /h
Noise level (boost)	39-56(69) dB
Energy efficiency class	A+
Ventilation type	Extraction/Recirculation
Motor power	160 W
Lighting power	8 W
Lighting functions	Warm2Cold LED; adjustable intensity and colour temperature
Charcoal filter (type)	FWK228, Long Life 228
Charcoal filter included	No
Minimum distance from electric hob	45 cm
Minimum distance from gas hob	65 cm
Air outlet diameter	Ø 150
Control type	Gesture control
Speed levels	4
Alternative control	Control via induction hob, remote control
Rotatable motor	None
Hob-to-hood communication (Cook Assist)	Yes
External motor connection option (Outvent)	Yes
Net weight	16 kg
Adapt Flow technology	Yes

Technologies

									
Warm2ColdLED	GestureControl	Remote control	BLDC motor	Anti Fingerprint	Fluted surface	Flexible installation	Cook Assist	Perimeter extraction	Adapt Flow

Technical drawing

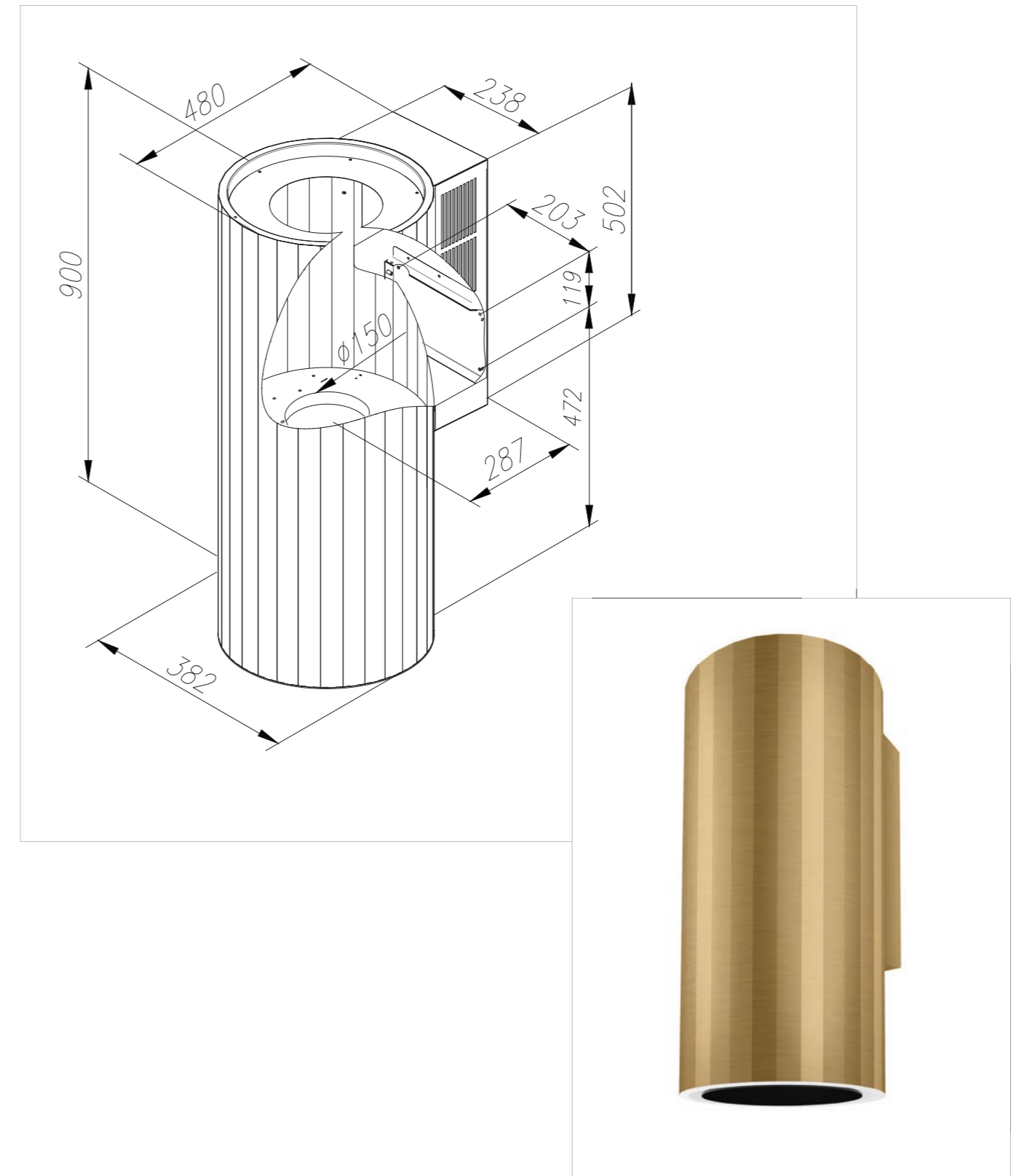







TUBUS

TUBUS

wall mounted hood

It is a **timeless classic**, whose **slim cylindrical form** brings **visual lightness and a modern touch** to the kitchen. Crafted with **precision from high-quality materials**, this **minimalist design** is not only a **striking feature**, but also an **exceptionally durable element**. Thanks to its **compact structure** and **high performance**, the model perfectly fills the space above the hob, making it an **ideal choice for those who value clean design without compromising extraction power**.



	Anti Fingerprint
	Warm2Cold lighting
	GestureControl
	BLDC motor
	Cook Assist

COLOR OPTIONS











TUBUS

wall mounted hood

Basic specifications

Hood type	Wall-mounted
Dimensions (H × W × D)	800 × 382 × 480 mm
Airflow (min-max / boost)	160-370 (670) m ³ /h
Noise level (boost)	39-56 (69) dB
Energy efficiency class	A+
Ventilation type	Extraction/Recirculation
Motor power	160 W
Lighting power	8 W
Lighting functions	Warm2Cold LED; adjustable intensity and colour temperature
Charcoal filter (type)	FWK228, Long Life 228
Charcoal filter included	No
Minimum distance from electric hob	45 cm
Minimum distance from gas hob	65 cm
Air outlet diameter	Ø 150 mm
Control type	Gesture control
Speed levels	4
Alternative control	Control via induction hob, remote control
Rotatable motor	None
Hob-to-hood communication (Cook Assist)	Yes
External motor connection option (Outvent)	Yes
Net weight	19 kg
Adapt Flow technology	Yes

Technologies

								
Warm2ColdLED	GestureControl	Remote control	BLDC motor	Anti Fingerprint	Flexible installation	Cook Assist	Perimeter extraction	Adapt Flow

Technical drawing

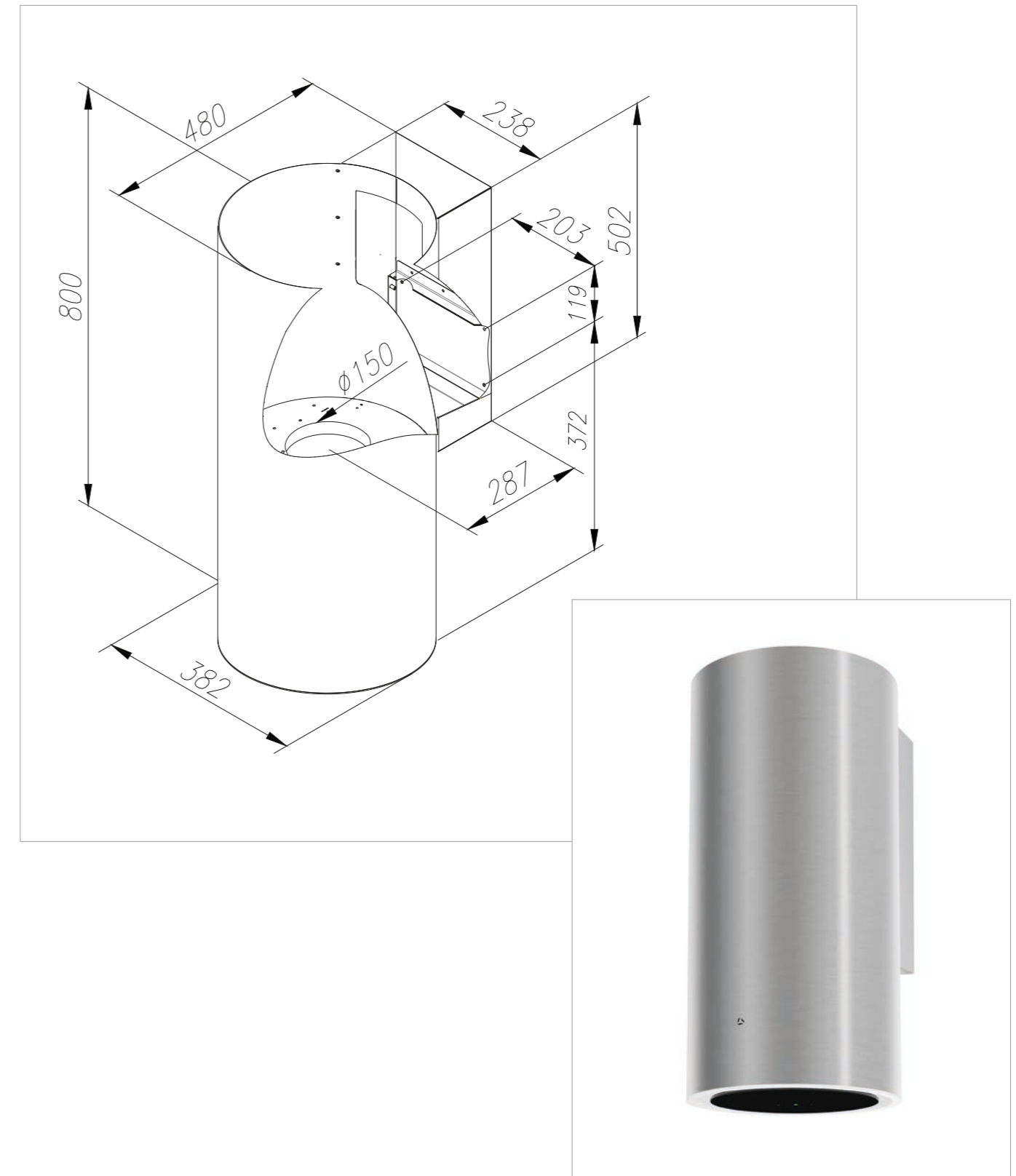







ECLIPSE

ECLIPSE

wall mounted hood

It is a **bold design inspired by astronomical phenomena**, capturing attention with its **perfectly circular form**. The **glass front** conceals an **advanced perimeter extraction system**, combining **futuristic aesthetics** with **high performance and quiet operation**.

Ambient lighting completes the design, transforming the extractor after dark into a **striking illuminated sculpture on the kitchen wall**.

	SmartSense Light
	Warm2Cold lighting
	GestureControl
	BLDC motor
	Flexible installation

COLOR OPTIONS









ECLIPSE

wall mounted hood

Basic specifications

Hood type	Wall-mounted
Dimensions (H x W x D)	600 x 600 x 338 mm
Airflow (min-max / boost)	215-540 (735) m ³ /h
Noise level (boost)	44-64 (70) dB
Energy efficiency class	A++
Ventilation type	Recirculation
Motor power	160 W
Lighting power	5 W
Lighting functions	Warm2ColdLED
Charcoal filter (type)	Long Life E
Charcoal filter included	Yes
Minimum distance from electric hob	45 cm
Minimum distance from gas hob	65 cm
Air outlet diameter	Ø 150
Control type	Gesture control
Speed levels	4
Alternative control	Touch on glass, remote control
Rotatable motor	No
Hob-to-hood communication (Cook Assist)	No
External motor connection option (Outvent)	No
Net weight	15 kg
Adapt Flow technology	No

Technologies

					
Warm2ColdLED	GestureControl	Remote control	BLDC motor	Flexible installation	SmartSense Light

Technical drawing

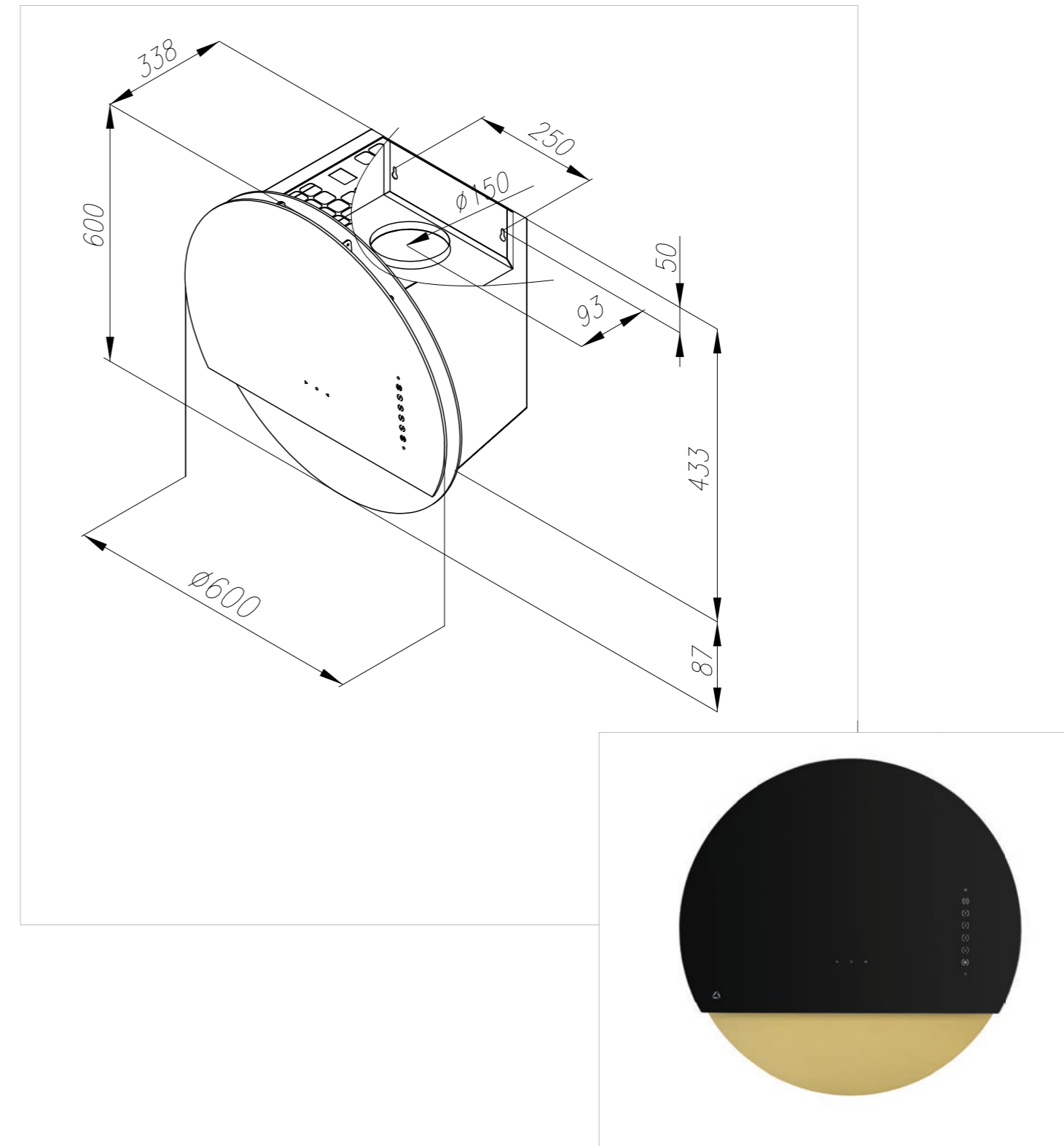





TRIO

wall mounted hood

It is an **unconventional design based on the rhythm of three forms**, bringing a **unique, almost architectural order** to the kitchen. The **triple structure** not only stands out with its **geometric aesthetics**, but also ensures **high-efficiency vapour extraction across the entire cooking area**.

The **refined finish and minimalist detailing** make this model an **ideal choice for those seeking solutions beyond standard interior design schemes**.

	SmartSense Light
	Warm2Cold lighting
	GestureControl
	BLDC motor
	Flexible installation

COLOR OPTIONS









TRIO

wall mounted hood

Basic specifications

Hood type	Wall-mounted
Dimensions (H x W x D)	450 x 898 x 403 mm
Airflow (min-max / boost)	230-550 (740) m ³ /h
Noise level (boost)	45-64 (70) dB
Energy efficiency class	A++
Ventilation type	Extraction/Recirculation
Motor power	160 W
Lighting power	7 W
Lighting functions	Warm2ColdLED
Charcoal filter (type)	FWND185/V2
Charcoal filter included	No
Minimum distance from electric hob	45 cm
Minimum distance from gas hob	65 cm
Air outlet diameter	Ø 150
Control type	Gesture control
Speed levels	4
Alternative control	Touch on glass, remote control
Rotatable motor	Yes
Hob-to-hood communication (Cook Assist)	Yes
External motor connection option (Outvent)	Yes
Net weight	22,7 kg
Adapt Flow technology	No

Technologies

						
Warm2ColdLED	GestureControl	Remote control	Silnik BLDC	Rotatable motor	Flexible installation	SmartSense Light

Technical drawing

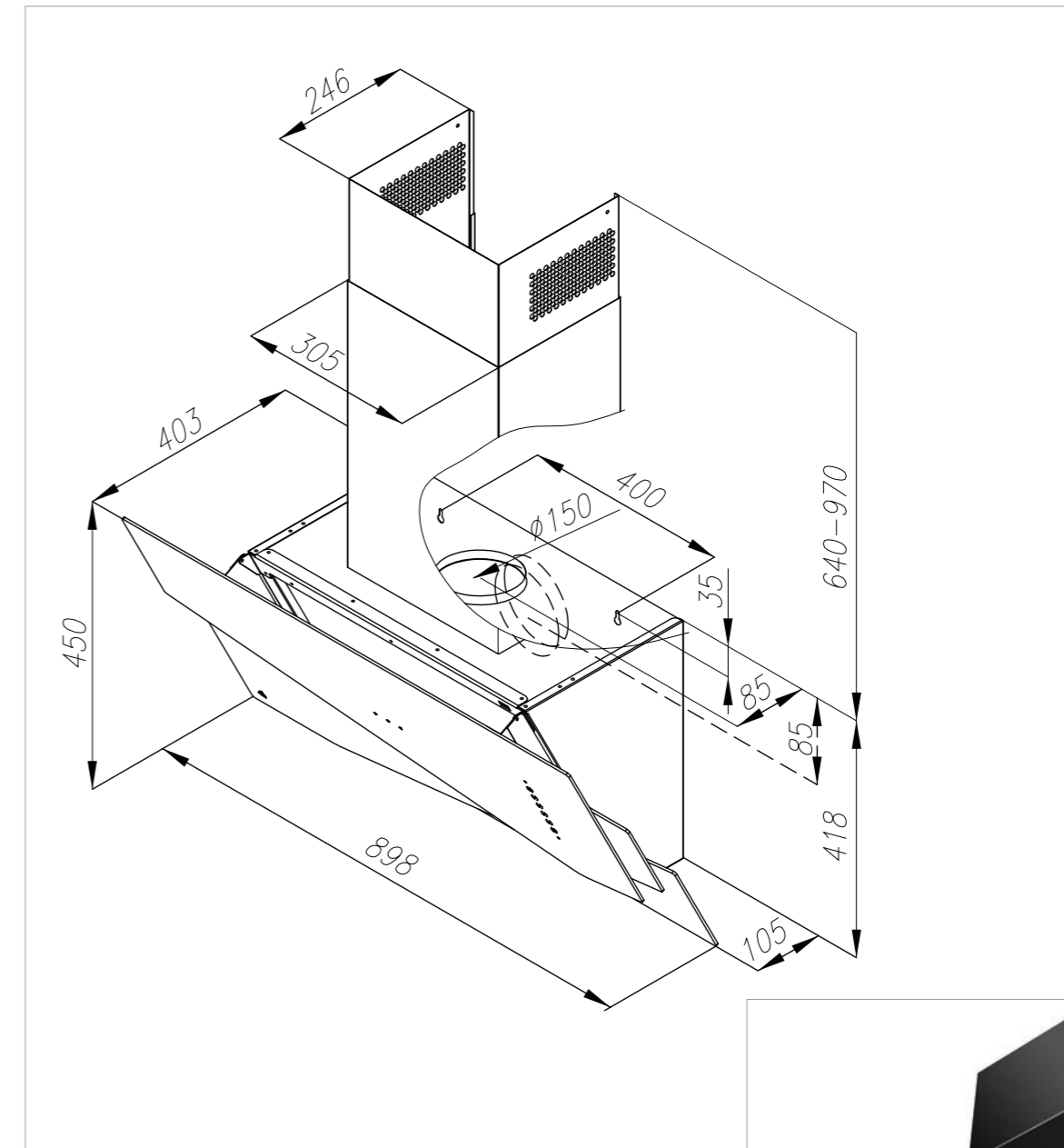







MINIMAL 3

wall mounted hood

This is an **ultra-compact wall-mounted extractor**, just **40 cm wide**, with a **flat vertical design** ideal for **smaller, demanding spaces**. At its core is a **professional-grade stainless steel Baffle filter**, ensuring **excellent grease absorption even during intensive cooking**. The **satin finish** protects the surface from **fingerprints and dust**, maintaining a **deep, elegant black look** every day.

	Anti Fingerprint
	Warm2Cold lighting
	GestureControl
	BLDC motor
	Baffle filter

COLOR OPTIONS











MINIMAL 3

wall mounted hood

Basic specifications

Hood type	Wall-mounted
Dimensions (H x W x D)	700 x 400 x 310 mm
Airflow (min-max / boost)	150-350 (610) m ³ /h
Noise level (boost)	43-58 (69) dB
Energy efficiency class	A+
Ventilation type	Extraction/Recirculation
Motor power	160 W
Lighting power	7 W
Lighting functions	Warm2Cold LED; adjustable intensity and colour temperature
Charcoal filter (type)	Long Life M3
Charcoal filter included	No
Minimum distance from electric hob	45 cm
Minimum distance from gas hob	65 cm
Air outlet diameter	Ø 150
Control type	Gesture control
Speed levels	4
Alternative control	Remote control
Rotatable motor	Yes
Hob-to-hood communication (Cook Assist)	No
External motor connection option (Outvent)	No
Net weight	7,5 kg
Adapt Flow technology	No

Technologies

							
Warm2ColdLED	GestureControl	Remote control	BLDC motor	Anti Fingerprint	Flexible installation	Baffle filter	Rotatable motor

Technical drawing

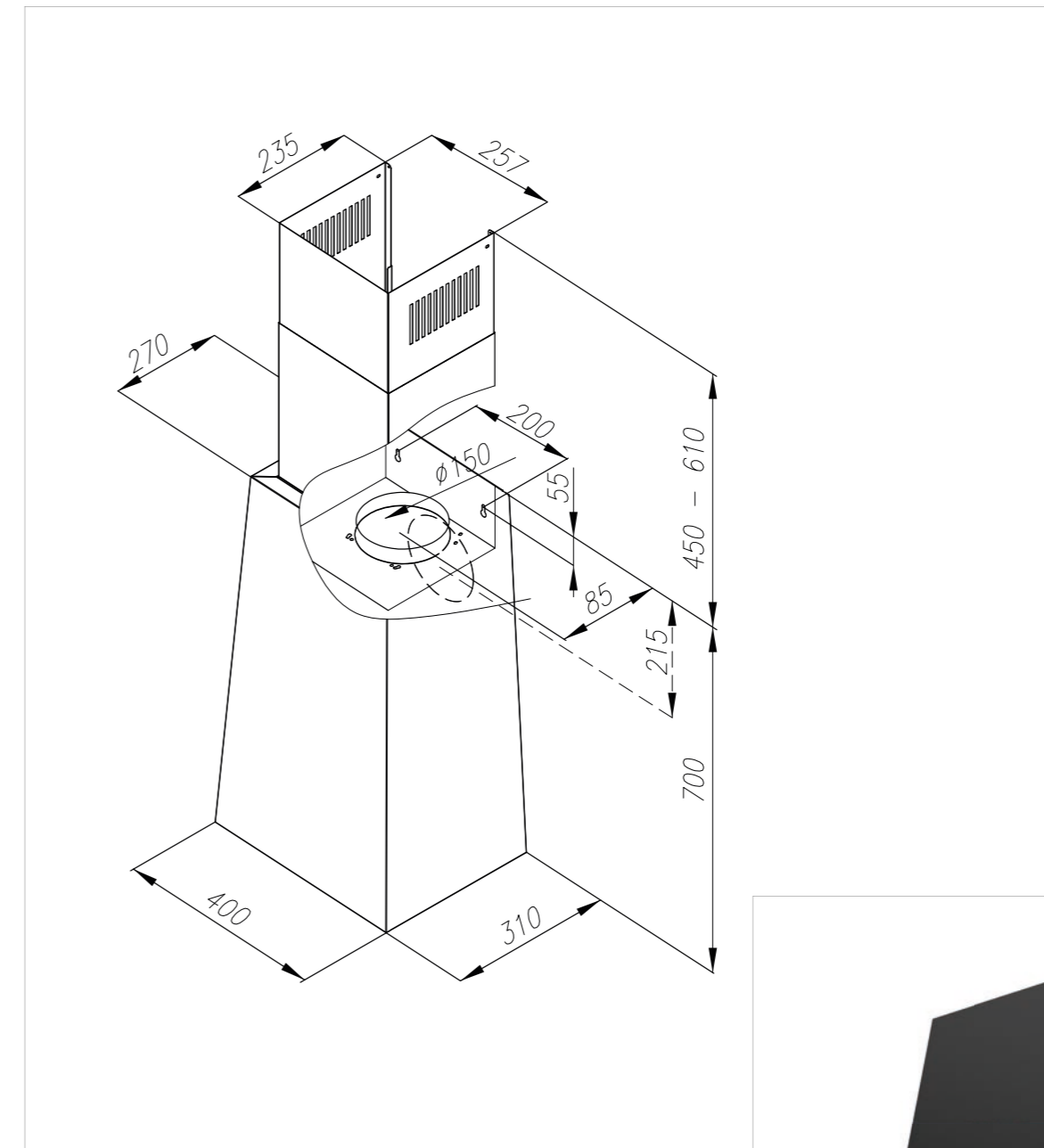





MINIMAL 4

wall mounted hood

It embraces a **timeless rectangular form**, perfectly suited to both **classic and modern kitchens**. The **smooth, button-free black front** highlights its **minimalist design**, while **gesture control** keeps the **matte surface clean and flawless**.

The **reversible motor** offers **flexible installation options**, and **adjustable light temperature** allows you to **match the lighting to the interior mood**. It is a **harmonious blend of traditional shape and smart features**, including an **anti-fingerprint finish**.



	Anti Fingerprint
	Warm2Cold lighting
	GestureControl
	BLDC motor
	Baffle filter

COLOR OPTIONS











MINIMAL 4

wall mounted hood

Basic specifications

Hood type	Wall-mounted
Dimensions (H x W x D)	900 x 382 x 480 mm
Airflow (min-max / boost)	160-370 (670) m ³ /h
Noise level (boost)	39-56(69) dB
Energy efficiency class	A+
Ventilation type	Extraction/Recirculation
Motor power	160 W
Lighting power	8 W
Lighting functions	Warm2Cold LED; adjustable intensity and colour temperature
Charcoal filter (type)	FWK228, Long Life 228
Charcoal filter included	No
Minimum distance from electric hob	45 cm
Minimum distance from gas hob	65 cm
Air outlet diameter	Ø 150
Control type	Gesture control
Speed levels	4
Alternative control	Remote control
Rotatable motor	No
Hob-to-hood communication (Cook Assist)	Yes
External motor connection option (Outvent)	Yes
Net weight	19 kg
Adapt Flow technology	No

Technologies

							
Warm2ColdLED	GestureControl	Remote control	BLDC motor	Anti Fingerprint	Flexible installation	Baffle filter	Rotatable motor



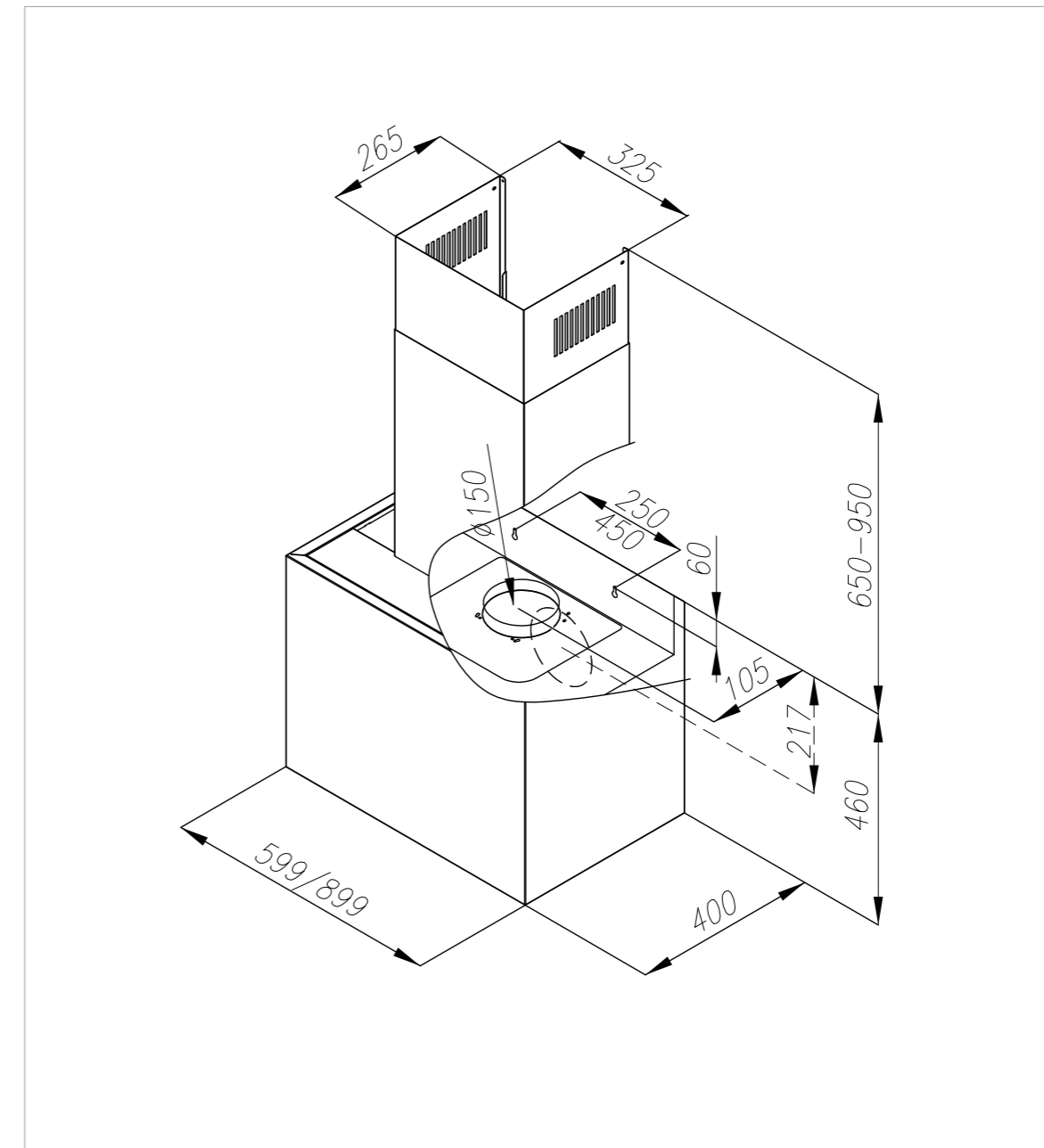

Technical drawing



MINIMAL 5

wall mounted hood

It is the **essence of geometric elegance**, concealing a **highly flexible interior** beneath its **smudge-resistant form**. The **unique rotatable motor** allows for **air extraction either upwards or directly through the rear wall**. **Touchless gesture control** and **Warm2Cold LED lighting** ensure **maximum comfort during every cooking experience**.

	Anti Fingerprint
	Warm2Cold lighting
	GestureControl
	BLDC motor
	Baffle filter

COLOR OPTIONS











MINIMAL 5

wall mounted hood

Basic specifications

Hood type	Wall-mounted
Dimensions (H x W x D)	60 cm - 460 x 599 x 400 mm 90 cm - 460 x 899 x 400 mm
Airflow (min-max / boost)	60 cm - 200-450 (700) m ³ /h 90 cm - 210-470 (715) m ³ /h
Noise level (boost)	60 cm - 42-58 (67) dB 90 cm - 43-59 (69) dB
Energy efficiency class	60 cm - A+++, 90 cm - A+++
Ventilation type	Extraction/Recirculation
Motor power	160 W
Lighting power	3 W
Lighting functions	Warm2Cold LED; adjustable intensity and colour temperature
Charcoal filter (type)	Long Life M4 / Long Life M6
Charcoal filter included	No
Minimum distance from electric hob	45 cm
Minimum distance from gas hob	65 cm
Air outlet diameter	Ø 150
Control type	Gesture control
Speed levels	4
Alternative control	Remote control
Rotatable motor	Yes
Hob-to-hood communication (Cook Assist)	No
External motor connection option (Outvent)	No
Net weight	60 cm- 15 kg, 90 cm - 19 kg
Adapt Flow technology	No

Technologies

							
Warm2ColdLED	GestureControl	Remote control	BLDC motor	Anti Fingerprint	Flexible installation	Baffle filter	Rotatable motor





Technical drawing



MINIMAL 6

wall mounted hood

It features an **avant-garde design** that turns the extractor into a **striking centrepiece of the kitchen**. The **visible Baffle filter** adds an **industrial touch**, while **GestureControl** ensures **effortless, touchless operation**. The **matte black finish** resists fingerprints, and **adjustable LED lighting** enhances both **functionality and form**.

	Anti Fingerprint
	Warm2Cold lighting
	GestureControl
	BLDC motor
	Baffle filter

COLOR OPTIONS











MINIMAL 6

wall mounted hood

Basic specifications

Hood type	Wall-mounted
Dimensions (H x W x D)	900 x 382 x 480 mm
Airflow (min-max / boost)	160-370 (670) m ³ /h
Noise level (boost)	39-56(69) dB
Energy efficiency class	A+
Ventilation type	Extraction/Recirculation
Motor power	160 W
Lighting power	8 W
Lighting functions	Warm2Cold LED; adjustable intensity and colour temperature
Charcoal filter (type)	FWK228, Long Life 228
Charcoal filter included	No
Minimum distance from electric hob	45 cm
Minimum distance from gas hob	65 cm
Air outlet diameter	Ø 150
Control type	Gesture control
Speed levels	4
Alternative control	Remote control
Rotatable motor	No
Hob-to-hood communication (Cook Assist)	Yes
External motor connection option (Outvent)	Yes
Net weight	16 kg
Adapt Flow technology	No

Technologies

							
Warm2ColdLED	GestureControl	Remote control	BLDC motor	Anti Fingerprint	Flexible installation	Baffle filter	Rotatable motor



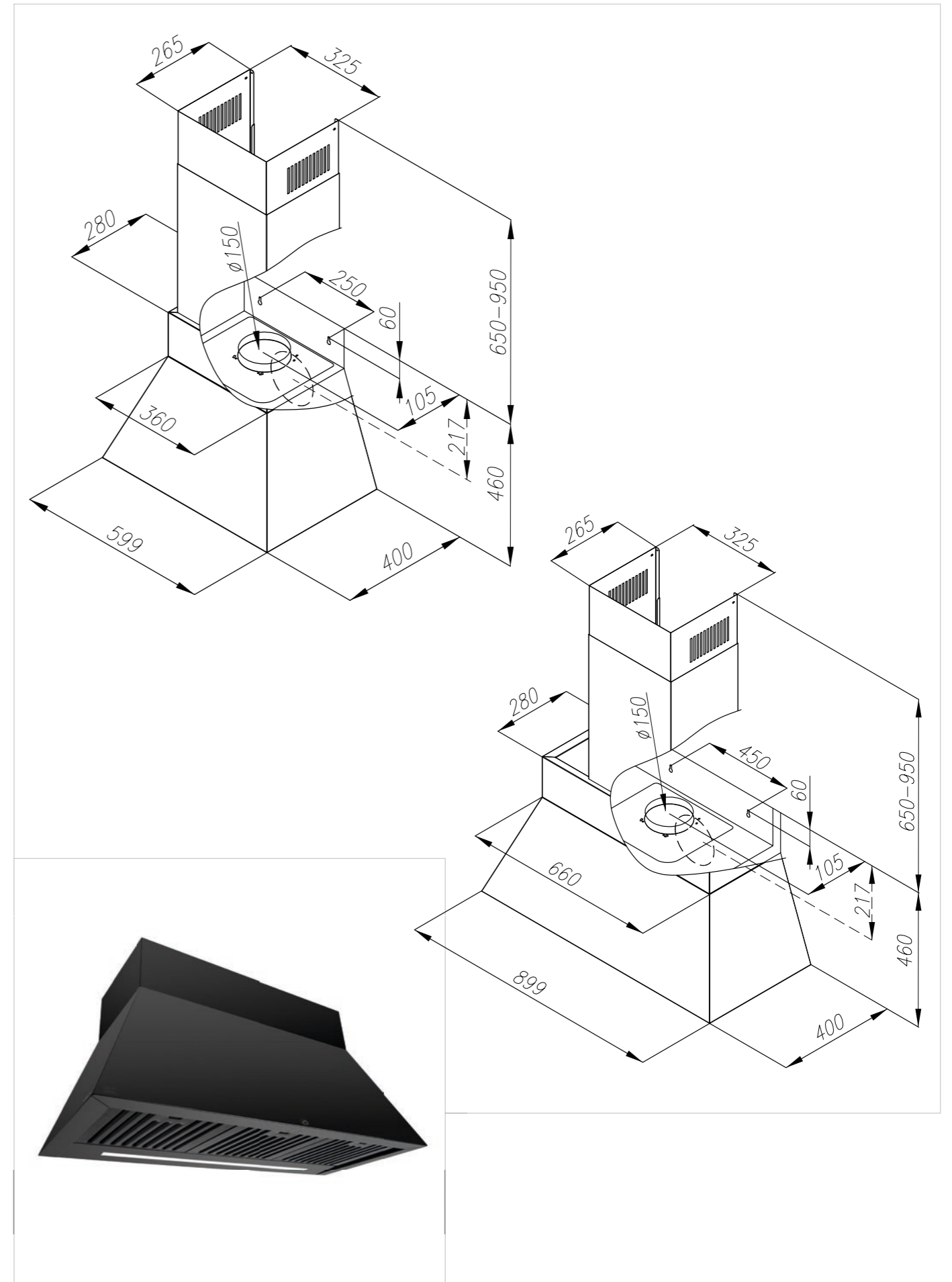

Technical drawing



MINIMAL 8

wall mounted hood

This is a **luxury wall-mounted extractor with a classic design**, distinguished by its **top-tier A+++ energy rating** and **exceptionally low power consumption**. It features an **innovative automatic air refresh function**, which **periodically ventilates the kitchen**, activating itself for several minutes at a time. The **matte AntiFingerprint finish** and **advanced BLDC motor** make it an appliance that is **as elegant as it is intelligent**.

	Air Refresh Function
	Warm2Cold lighting
	GestureControl
	BLDC motor
	Cook Assist

COLOR OPTIONS











MINIMAL 8

wall mounted hood

Basic specifications

Hood type	Wall-mounted
Dimensions (H x W x D)	790-1010 x 900 x 500 mm
Airflow (min-max / boost)	200-515 (720) m ³ /h
Noise level (boost)	44-63 (68) dB
Energy efficiency class	A++
Ventilation type	Extraction/Recirculation
Motor power	160 W
Lighting power	12 W
Lighting functions	Warm2Cold LED; adjustable intensity and colour temperature
Charcoal filter (type)	FWND185/V2
Charcoal filter included	No
Minimum distance from electric hob	45 cm
Minimum distance from gas hob	65 cm
Air outlet diameter	Ø 150
Control type	Gesture control, remote control, touch control
Speed levels	4
Alternative control	Remote control
Rotatable motor	No
Hob-to-hood communication (Cook Assist)	No
External motor connection option (Outvent)	No
Net weight	16 kg
Adapt Flow technology	No

Technologies

							
Warm2ColdLED	GestureControl	Remote control	BLDC motor	Anti Fingerprint	Flexible installation	Baffle filter	Rotatable motor



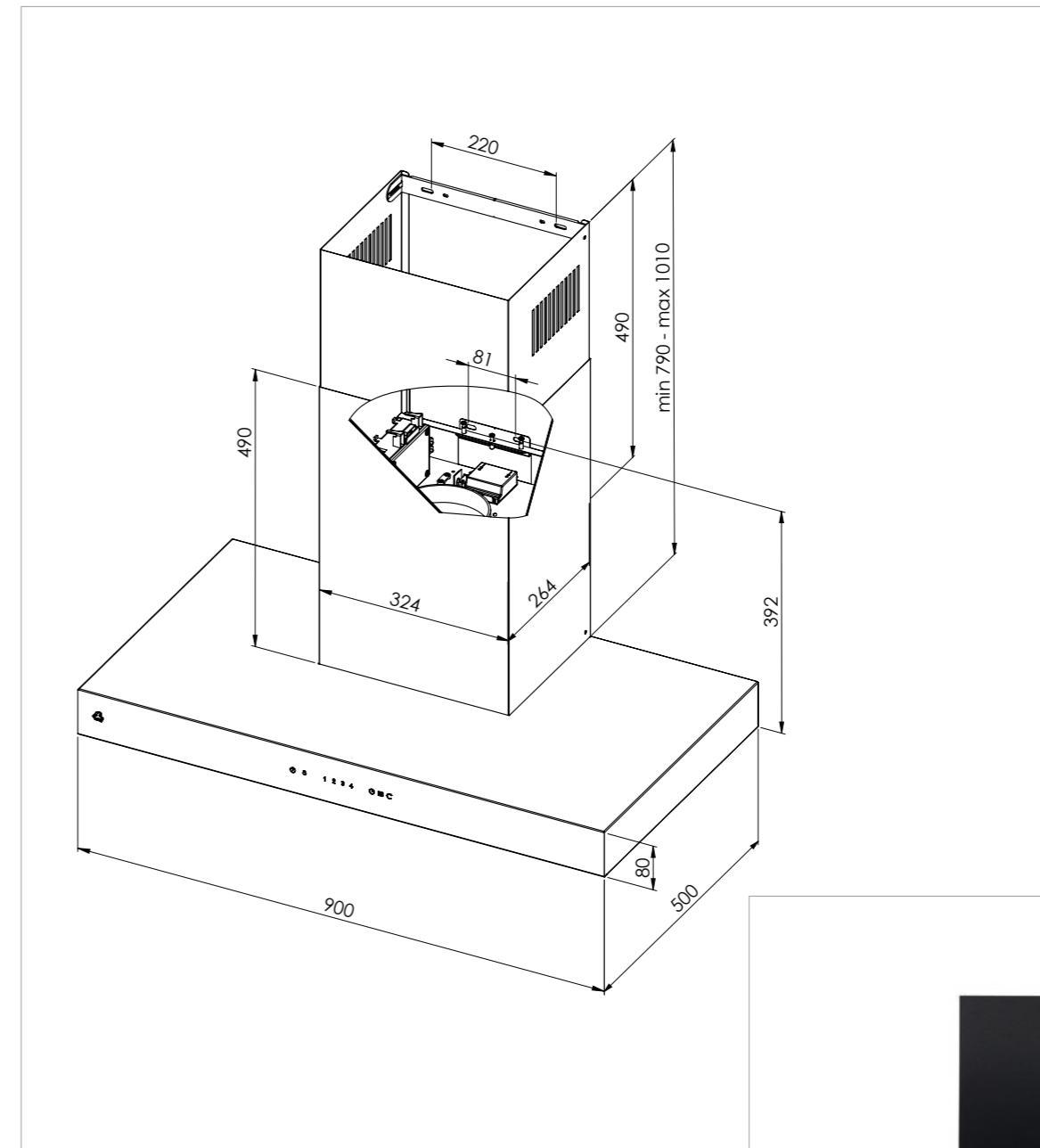

Technical drawing



T-LIGHT

wall mounted hood

draws attention with its **elegant inverted "T"** shape, fitting perfectly into **modern and loft-style interiors**. It is equipped with **touchless gesture control and integrated LED lighting**, which **perfectly illuminates the entire cooking area**. Its **powerful motor** quickly eliminates vapours, ensuring **clean air** while maintaining the **highest level of energy efficiency**.

	Anti Fingerprint
	Warm2Cold lighting
	GestureControl
	BLDC motor
	Cook Assist

COLOR OPTIONS









T-LIGHT

wall mounted hood

Basic specifications

Hood type	Wall-mounted
Dimensions (H × W × D)	60 cm - 810-1030 x 599 x 500 mm 90 cm - 810-1030 x 899 x 500 mm
Airflow (min-max / boost)	60 cm - 200-505 (690) m ³ /h 90 cm - 210-520 (705) m ³ /h
Noise level (boost)	60 cm - 43-62 (69) dB 90 cm - 43-62 (69) dB
Energy efficiency class	A++
Ventilation type	Extraction/Recirculation
Motor power	160 W
Lighting power	12 W
Lighting functions	Warm2Cold LED; adjustable intensity and colour temperature
Charcoal filter (type)	FWND185/V2, Longlife 300
Charcoal filter included	No
Minimum distance from electric hob	45 cm
Minimum distance from gas hob	65 cm
Air outlet diameter	Ø 150
Control type	Gesture control
Speed levels	4
Alternative control	Remote control
Rotatable motor	No
Hob-to-hood communication (Cook Assist)	Yes
External motor connection option (Outvent)	Yes
Net weight	16 kg
Adapt Flow technology	No

Technologies

						
Warm2ColdLED	GestureControl	Remote control	BLDC motor	Anti Fingerprint	Flexible installation	Rotatable motor

Technical drawing

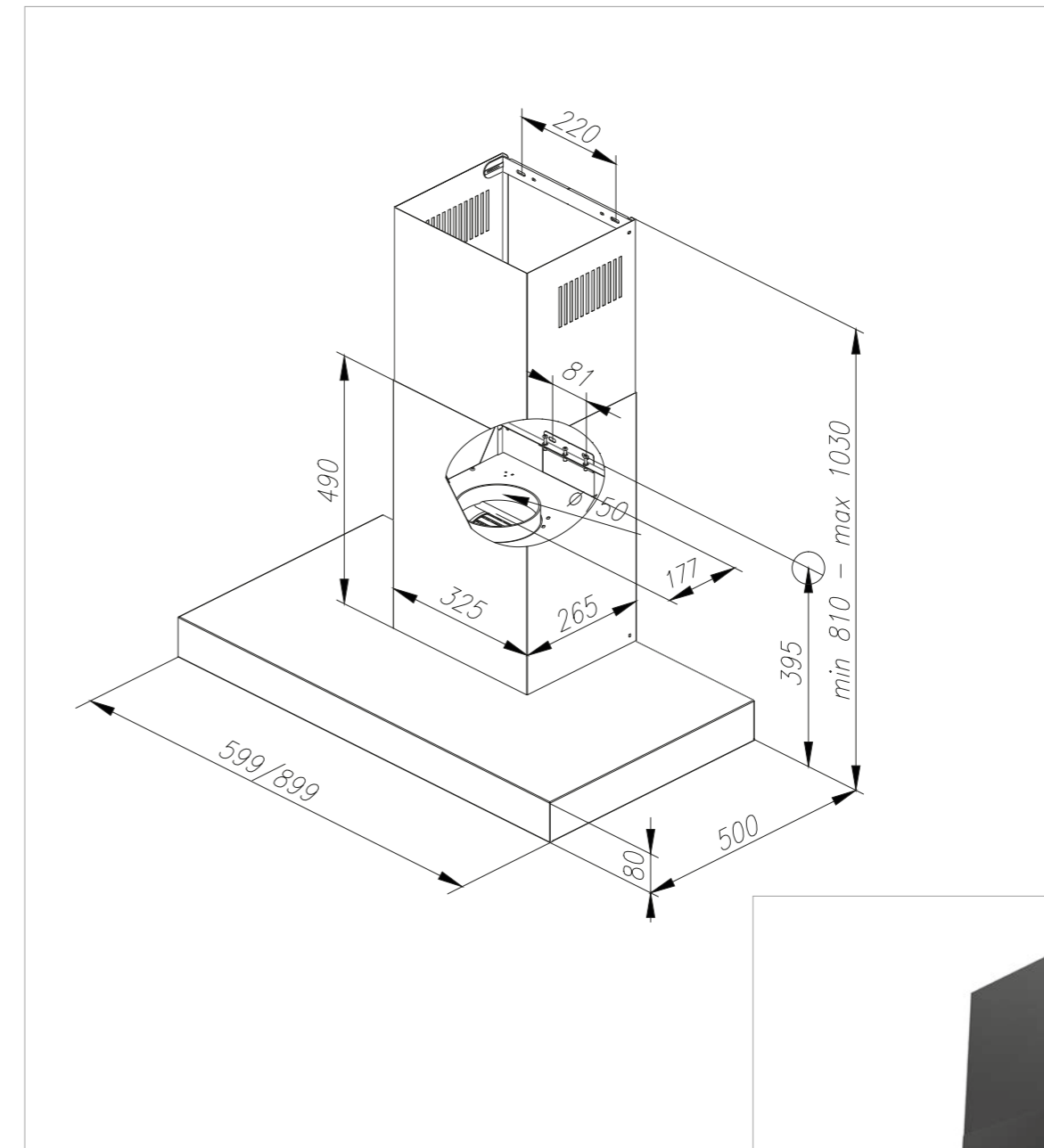

04

**ISLAND
HOODS**



island hood

A SPECTACULAR DESIGN STATEMENT THAT COMBINES ADVANCED TECHNOLOGY WITH A SCULPTURAL FORM AT THE HEART OF THE KITCHEN

ICON W



MONO W





MONO W

island hood

The **island version of the iconic Mono series** stands out with its **clean, cubist form with an oval profile**, perfectly suited to **loft-style and minimalist interiors**. The appliance impresses with its **powerful extraction performance** and **modern Anti-Fingerprint finish**, effectively eliminating visible smudges on the surface.

Precision craftsmanship is combined with an **intuitive control system** and **LED lighting**, which efficiently illuminates the entire cooking area.



	Proprietary fluted surface
	Warm2Cold lighting
	GestureControl
	BLDC motor
	Cook Assist

COLOR OPTIONS



TEXTURE, UP CLOSE

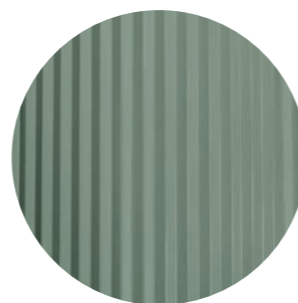

AWARDS













MONO W

island hood

Basic specifications

Hood type	Island
Dimensions (H x W x D)	1025-1200 x 899 x 240 mm
Airflow (min-max / boost)	230-550 (550) m³/h
Noise level (boost)	41-61 (69) dB
Energy efficiency class	A+
Ventilation type	Recirculation
Motor power	160 W
Lighting power	5 W
Lighting functions	Warm2Cold LED; adjustable intensity and colour temperature
Charcoal filter (type)	Long Life M/S
Charcoal filter included	Yes
Minimum distance from electric hob	45 cm
Minimum distance from gas hob	65 cm
Air outlet diameter	220 x 90 mm
Control type	Gesture control
Speed levels	4
Alternative control	Soft-touch buttons, control via induction hob
Rotatable motor	No
Hob-to-hood communication (Cook Assist)	Yes
External motor connection option (Outvent)	No
Net weight	22,5 kg
Adapt Flow technology	Yes

Technologies

									
Warm2ColdLED	GestureControl	Remote control	BLDC motor	Anti Fingerprint	Flexible installation	Cook Assist	Fluted surface	Perimeter extraction	Adapt Flow

Technical drawing

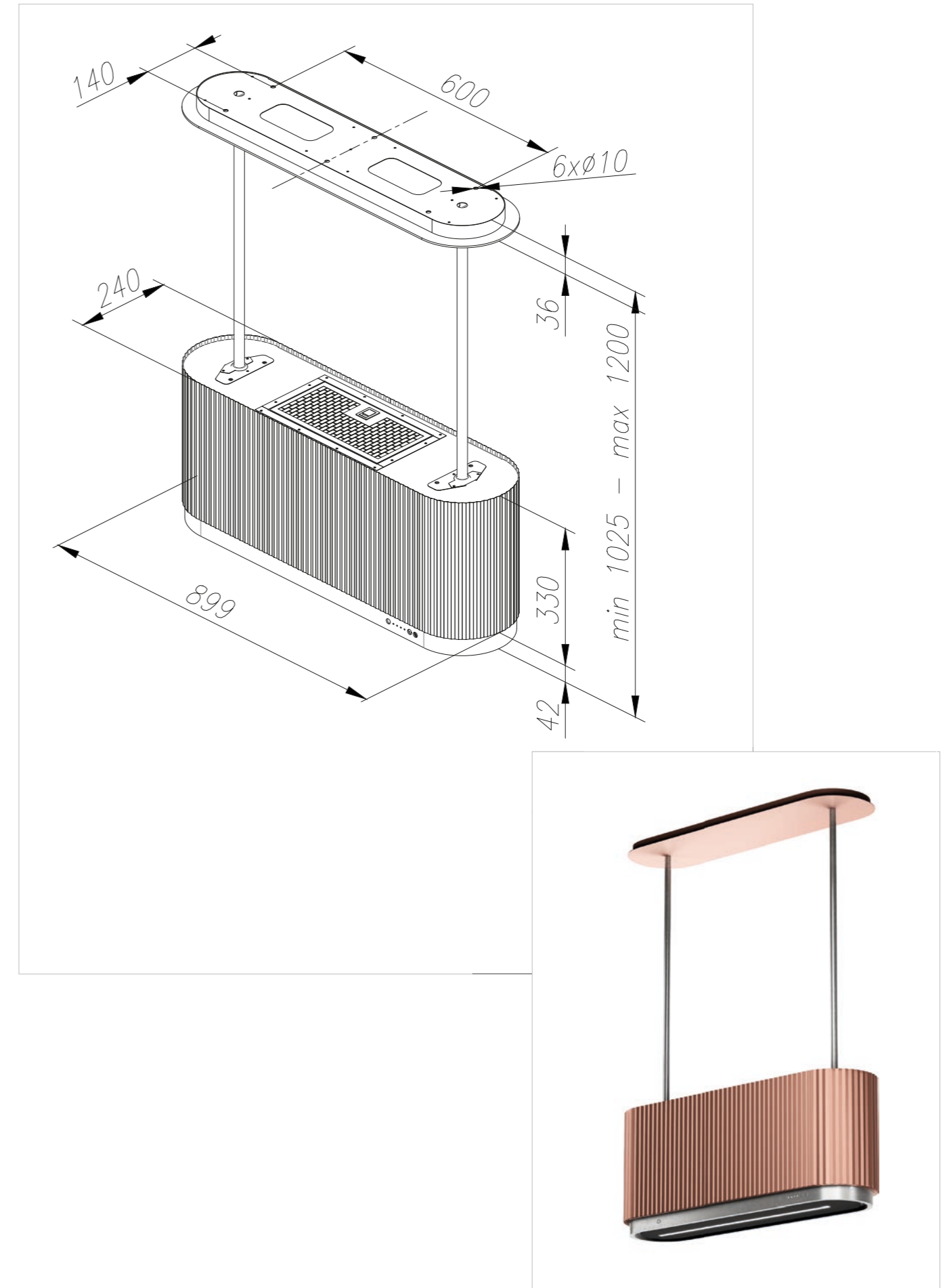







MINIMAL 2

island hood

It takes the form of a **modular frame**, allowing you to optionally attach **practical hooks for cups and glasses**. Subtle **LED lighting running along the entire perimeter** creates a **unique atmosphere** and perfectly illuminates the cooking area.

With **touchless GestureControl operation** and an **AntiFingerprint coating**, the appliance maintains a **flawless satin black finish at all times**.

	Hood personalisation
	Warm2Cold lighting
	GestureControl
	BLDC motor
	Anti Fingerprint

COLOR OPTIONS









MINIMAL 2

island hood

Basic specifications

Hood type	Island
Dimensions (H × W × D)	120 cm - 800-1100 x 1200 x 520 mm 180 cm - 800-1100 x 1800 x 520 mm
Airflow (min-max / boost)	120 cm - 185-415 (675) m³/h 180 cm - 185-415 (675) m³/h
Noise level (boost)	120 cm - 43-59 (69) dB 180 cm - 43-59 (69) dB
Energy efficiency class	A+
Ventilation type	Extraction/Recirculation
Motor power	120 cm - 160 W 180 cm - 160 W
Lighting power	12 W
Lighting functions	Warm2Cold LED; adjustable intensity and colour temperature
Charcoal filter (type)	120 cm - FWK280 180 cm - FWK300
Charcoal filter included	No
Minimum distance from electric hob	45 cm
Minimum distance from gas hob	65 cm
Air outlet diameter	Ø 150
Control type	Gesture control
Speed levels	4
Alternative control	Remote control
Rotatable motor	No
Hob-to-hood communication (Cook Assist)	Yes
External motor connection option (Outvent)	Yes
Net weight	46 kg
Adapt Flow technology	Yes

Technologies

						
Warm2ColdLED	GestureControl	Remote control	BLDC motor	Anti Fingerprint	Flexible installation	Hood personalisation

Technical drawing

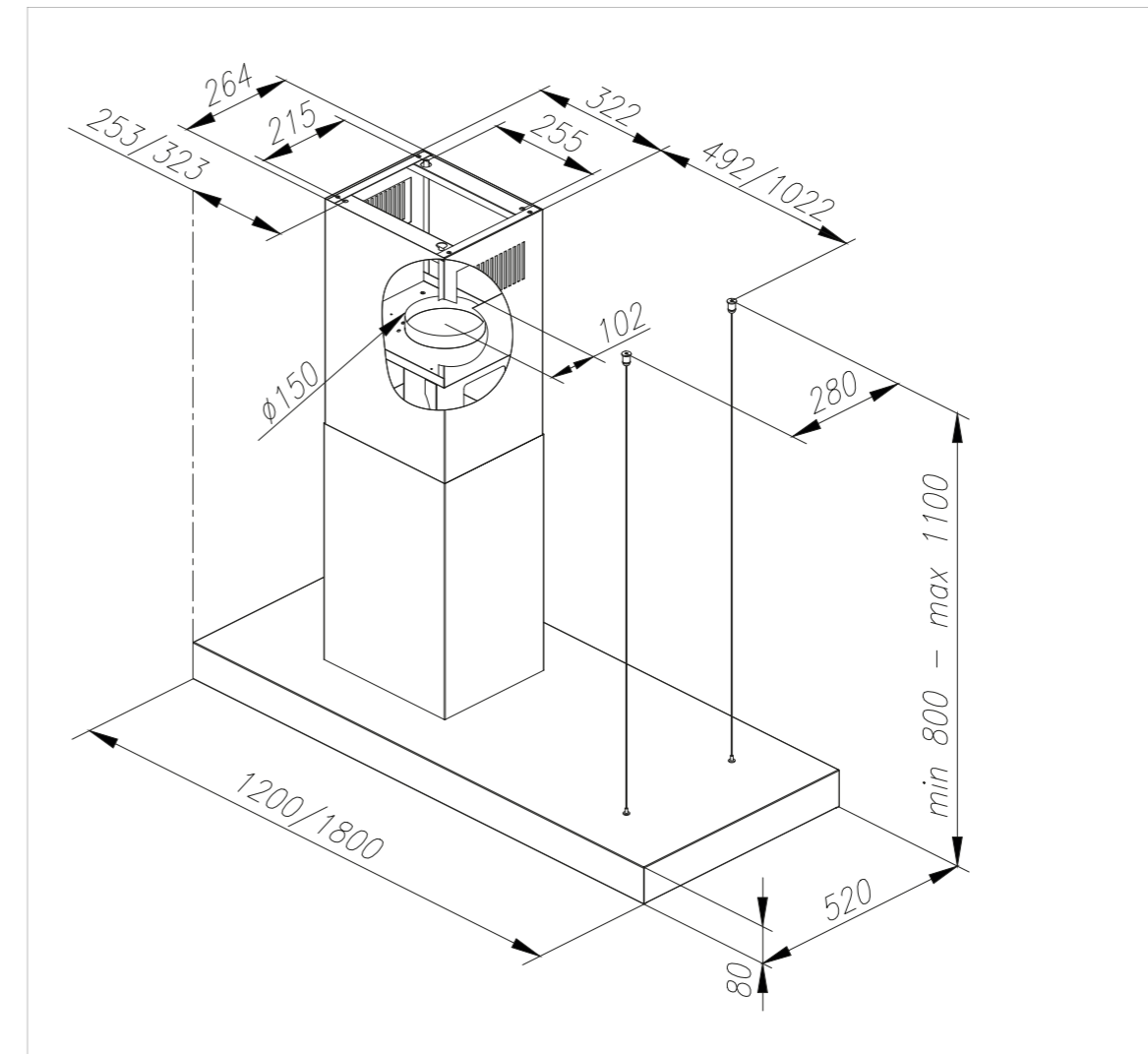







MINIMAL 1

MINIMAL 1

island hood

It is a **true highlight for lovers of industrial design**, enhanced with a **practical shelf for decorative items or cookbooks**. The **smooth surface with an AntiFingerprint coating** effectively prevents **unsightly smudges during everyday use**. The design is completed with **Warm2Cold LED lighting**, ensuring the **space above the kitchen island always looks stunning**.



	Hood personalisation
	Warm2Cold lighting
	GestureControl
	BLDC motor
	Filtr Baffle

COLOR OPTIONS



TEXTURE, UP CLOSE

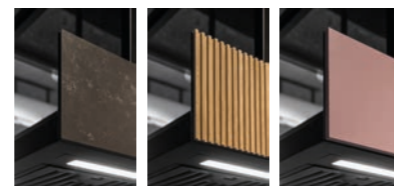









MINIMAL 1

island hood

Basic specifications

Hood type	Island
Dimensions (H × W × D)	90 cm - 930-1230 x 900 x 584 mm 120 cm - 930-1230 x 1200 x 584 mm
Airflow (min-max / boost)	90 cm - 180-290 (550) m ³ /h 120 cm - 180-290 (550) m ³ /h
Noise level (boost)	90 cm - 38-62 (72) dB 120 cm - 38-62 (72) dB
Energy efficiency class	90 cm - A+ 120 cm - A++
Ventilation type	Recirculation
Motor power	170 W
Lighting power	10 W
Lighting functions	Warm2Cold LED; adjustable intensity and colour temperature
Charcoal filter (type)	Long Life M1
Charcoal filter included	Yes
Minimum distance from electric hob	45 cm
Minimum distance from gas hob	65 cm
Air outlet diameter	No
Control type	Gesture control
Speed levels	4
Alternative control	Remote control
Rotatable motor	No
Hob-to-hood communication (Cook Assist)	No
External motor connection option (Outvent)	No
Net weight	45 kg
Adapt Flow technology	Yes

Technologies

								
Warm2ColdLED	GestureControl	Remote control	BLDC motor	Anti Fingerprint	Flexible installation	Baffle filter	Decorative space	Hood personalisation

Technical drawing

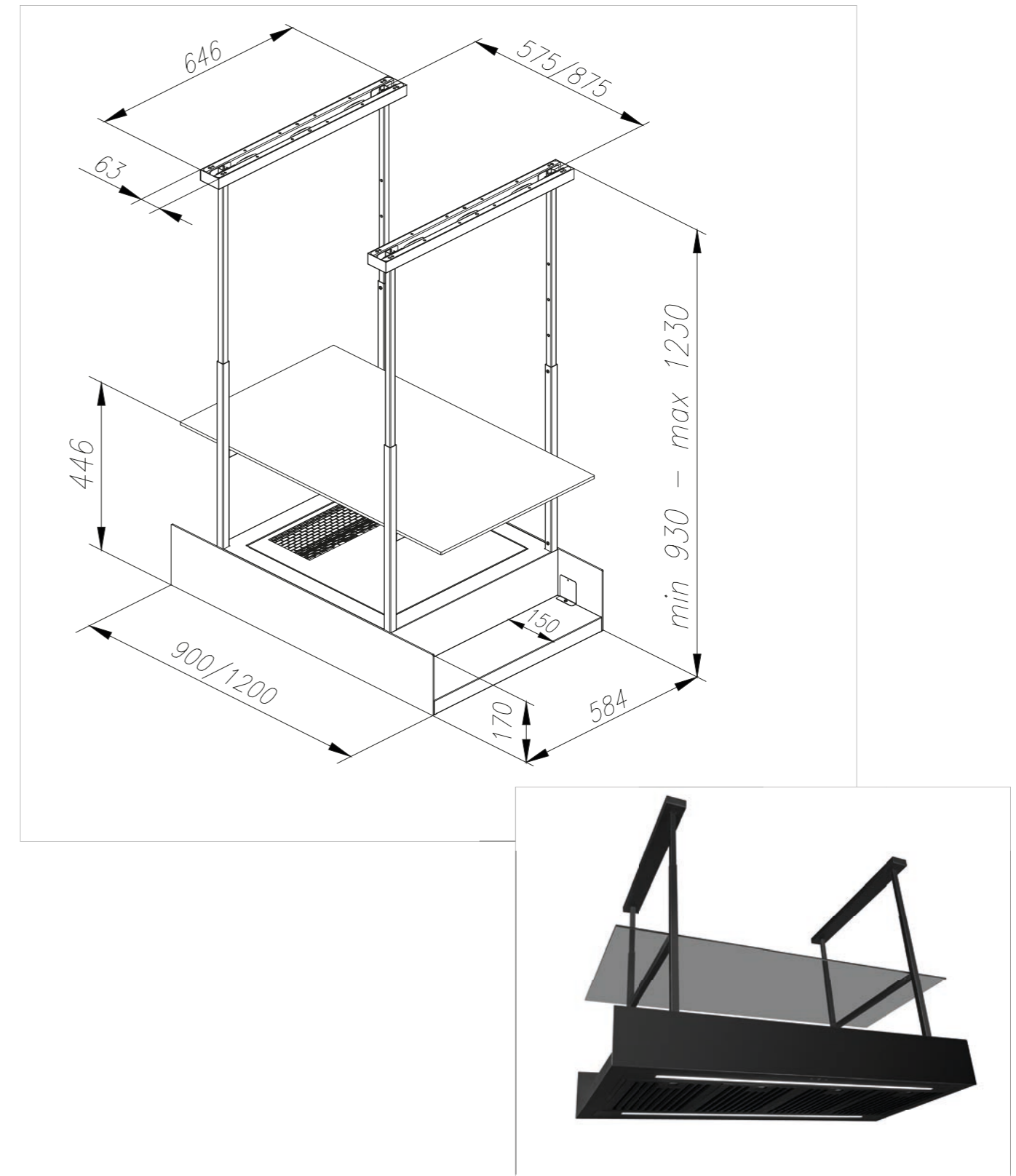

ICON W

island hood

It is a **luxurious, floating sculpture above the worktop**, combining the **prestige of premium materials** with a **pure, minimalist form**. Its **unique, suspended design**, reminiscent of a **work of art in mid-air**, conceals advanced **air purification technology controlled by intuitive gestures**.

With **meticulous attention to detail from every angle**, the extractor becomes a **prestigious focal point**, elegantly organizing the space of a **modern kitchen island**. It is a **striking fusion of engineering and architectural design** in home appliances.



	Internationally awarded design
	Warm2Cold lighting
	GestureControl
	BLDC motor
	Cook Assist

COLOR OPTIONS



AWARDS

IKONA '25
DOBRY
WZÓR

must
have











ICON W

island hood

Basic specifications

Hood type	Island
Dimensions (H x W x D)	958-1188 x Ø382 mm
Airflow (min-max / boost)	145-355 (655) m ³ /h
Noise level (boost)	38-56 (69) dB
Energy efficiency class	A+
Ventilation type	Extraction/Recirculation
Motor power	160 W
Lighting power	8 W
Lighting functions	Warm2Cold LED; adjustable intensity and colour temperature
Charcoal filter (type)	FWK228, Long Life 228
Charcoal filter included	No
Minimum distance from electric hob	45 cm
Minimum distance from gas hob	65 cm
Air outlet diameter	Ø 150
Control type	Gesture control
Speed levels	4
Alternative control	Control via induction hob, remote control
Rotatable motor	No
Hob-to-hood communication (Cook Assist)	Yes
External motor connection option (Outvent)	Yes
Net weight	18 kg
Adapt Flow technology	Yes

Technologies

								
Warm2ColdLED	GestureControl	Remote control	BLDC motor	Anti Fingerprint	Flexible installation	Cook Assist	Perimeter extraction	Adapt Flow

Technical drawing

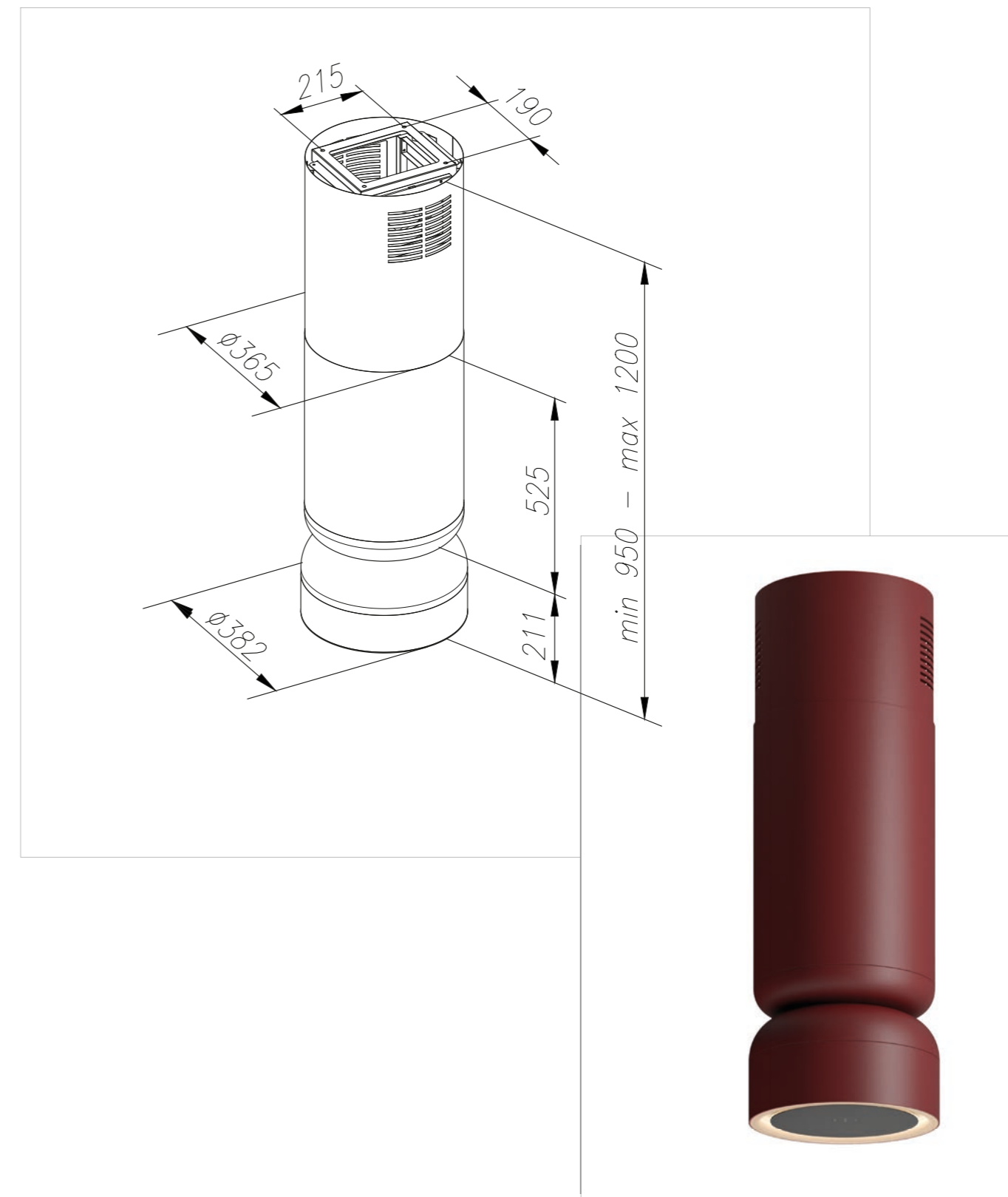



FLUO W





FLUO W

island hood

It is a **jewel-like accent suspended above the heart of the kitchen**, captivating with a **play of light and rich colours from every angle**. Its **unique form redefines the concept of an extractor**, transforming it into a **vibrant light sculpture** that dominates a modern living space.

Thanks to **touchless GestureControl technology**, operation is completely **hands-free**, preserving the **flawless appearance of its colourful finish**. It is a **bold choice for designers** who want the extractor to become the **central decorative element**, seamlessly connecting the kitchen with the rest of the home.



	Internationally awarded design
	Warm2Cold lighting
	GestureControl
	BLDC motor
	Cook Assist

COLOR OPTIONS











FLUO W

island hood

Basic specifications

Hood type	Island
Dimensions (H x W x D)	958-1188 x Ø384
Airflow (min-max / boost)	155-360 (660) m ³ /h
Noise level (boost)	38-56(69) dB
Energy efficiency class	A+
Ventilation type	Extraction/Recirculation
Motor power	160 W
Lighting power	8 W
Lighting functions	Warm2Cold LED; adjustable intensity and colour temperature
Charcoal filter (type)	FWK228, Long Life 228
Charcoal filter included	No
Minimum distance from electric hob	45 cm
Minimum distance from gas hob	65 cm
Air outlet diameter	Ø 150
Control type	Gesture control
Speed levels	4
Alternative control	Control via induction hob, remote control
Rotatable motor	No
Hob-to-hood communication (Cook Assist)	Yes
External motor connection option (Outvent)	Yes
Net weight	17,7 kg
Adapt Flow technology	Yes

Technologies

								
Warm2ColdLED	GestureControl	Remote control	BLDC motor	Anti Fingerprint	Flexible installation	Cook Assist	Perimeter extraction	Adapt Flow

Technical drawing

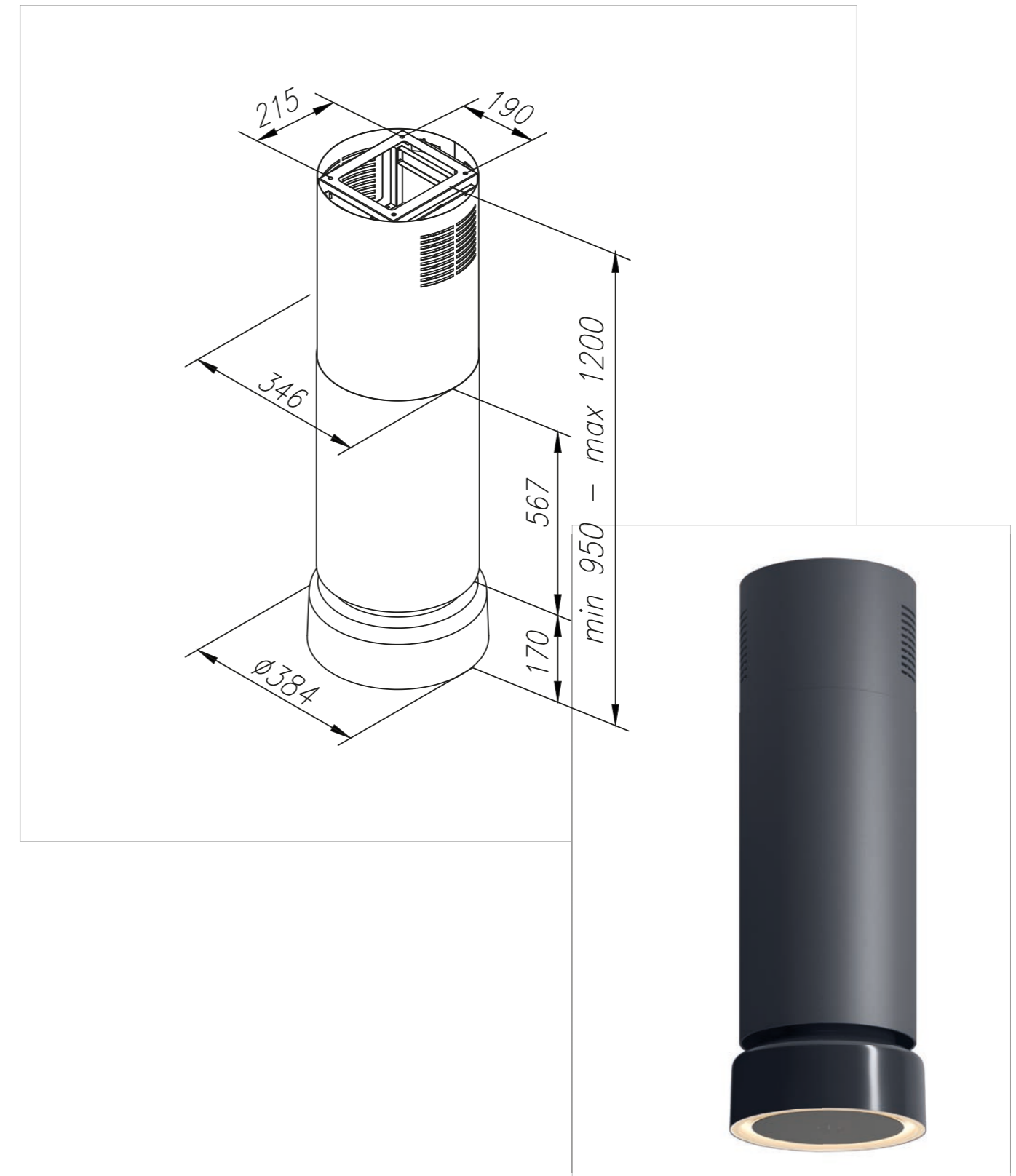







MONOGRAM W

MONOGRAM W

island hood

It combines **architectural rawness** with a **distinctive proprietary fluted surface**, adding **depth and a modern character** to the form. The **vertical grooves** play with light, creating a **striking three-dimensional effect** that turns the appliance into a **bold decorative feature in any kitchen**.

This attention to **material texture** not only enhances its **aesthetic appeal**, but also highlights its **premium, craftsmanship-driven character**.

	Proprietary fluted surface
	Warm2Cold lighting
	GestureControl
	BLDC motor
	Cook Assist

COLOR OPTIONS



TEXTURE, UP CLOSE

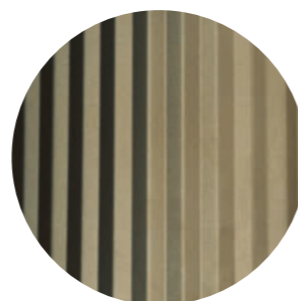











MONOGRAM W

island hood

Basic specifications

Hood type	Island
Dimensions (H × W × D)	958-1188 x Ø382 mm
Airflow (min-max / boost)	160-370 (670) m ³ /h
Noise level (boost)	39-56(69) dB
Energy efficiency class	A+
Ventilation type	Extraction/Recirculation
Motor power	160 W
Lighting power	8 W
Lighting functions	Warm2Cold LED; adjustable intensity and colour temperature
Charcoal filter (type)	FWK228, Long Life 228
Charcoal filter included	No
Minimum distance from electric hob	45 cm
Minimum distance from gas hob	65 cm
Air outlet diameter	Ø 150
Control type	Gesture control
Speed levels	4
Alternative control	Control via induction hob, remote control
Rotatable motor	No
Hob-to-hood communication (Cook Assist)	Yes
External motor connection option (Outvent)	Yes
Net weight	20,5 kg
Adapt Flow technology	Yes

Technologies

									
Warm2ColdLED	GestureControl	Remote control	BLDC motor	Anti Fingerprint	Flexible installation	Cook Assist	Fluted surface	Perimeter extraction	Adapt Flow

Technical drawing

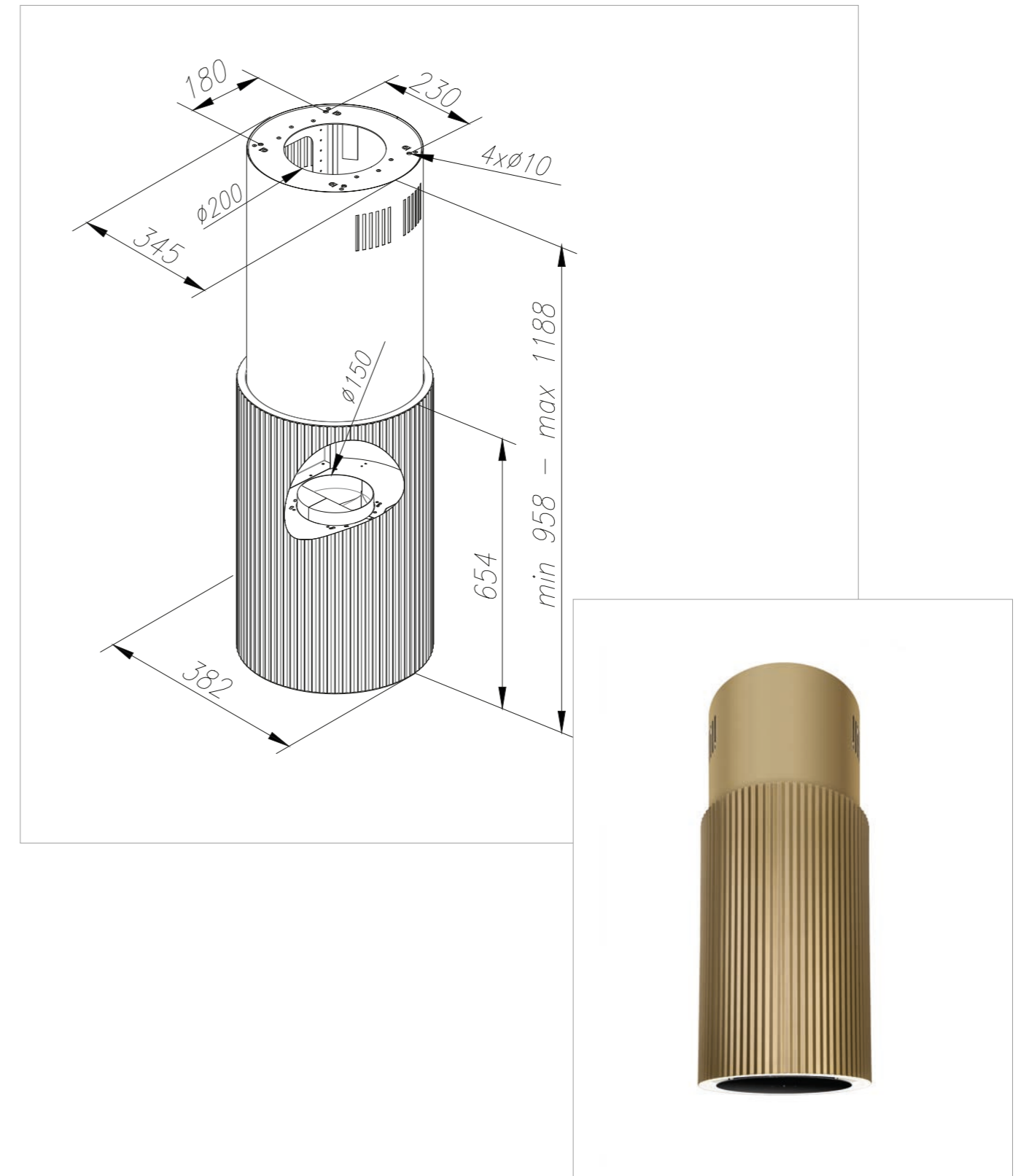



TUBUS W





TUBUS W

island hood

It is a **timeless classic**, whose **slim cylindrical form** brings **visual lightness and a modern touch** to the kitchen. Crafted with **precision from high-quality materials**, this **minimalist design** is not only a **striking feature**, but also an **exceptionally durable element**.

Thanks to its **compact structure** and **high performance**, the model perfectly fills the space above the hob, making it an **ideal choice for those who value clean design without compromising extraction power**.



	Anti Fingerprint
	Warm2Cold lighting
	GestureControl
	BLDC motor
	Cook Assist

COLOR OPTIONS











TUBUS W

island hood

Basic specifications

Hood type	Island
Dimensions (H x W x D)	958-1188 x Ø382 mm
Airflow (min-max / boost)	160-370 (670) m ³ /h
Noise level (boost)	39-56(69) dB
Energy efficiency class	A+
Ventilation type	Extraction/Recirculation
Motor power	160 W
Lighting power	8 W
Lighting functions	Warm2Cold LED; adjustable intensity and colour temperature
Charcoal filter (type)	FWK228, Long Life 228
Charcoal filter included	No
Minimum distance from electric hob	45 cm
Minimum distance from gas hob	65 cm
Air outlet diameter	Ø 150
Control type	Gesture control
Speed levels	4
Alternative control	Control via induction hob, remote control
Rotatable motor	No
Hob-to-hood communication (Cook Assist)	Yes
External motor connection option (Outvent)	Yes
Net weight	20,5 kg
Adapt Flow technology	Yes

Technologies

								
Warm2ColdLED	GestureControl	Remote control	BLDC motor	Anti Fingerprint	Flexible installation	Cook Assist	Perimeter extraction	Adapt Flow

Technical drawing

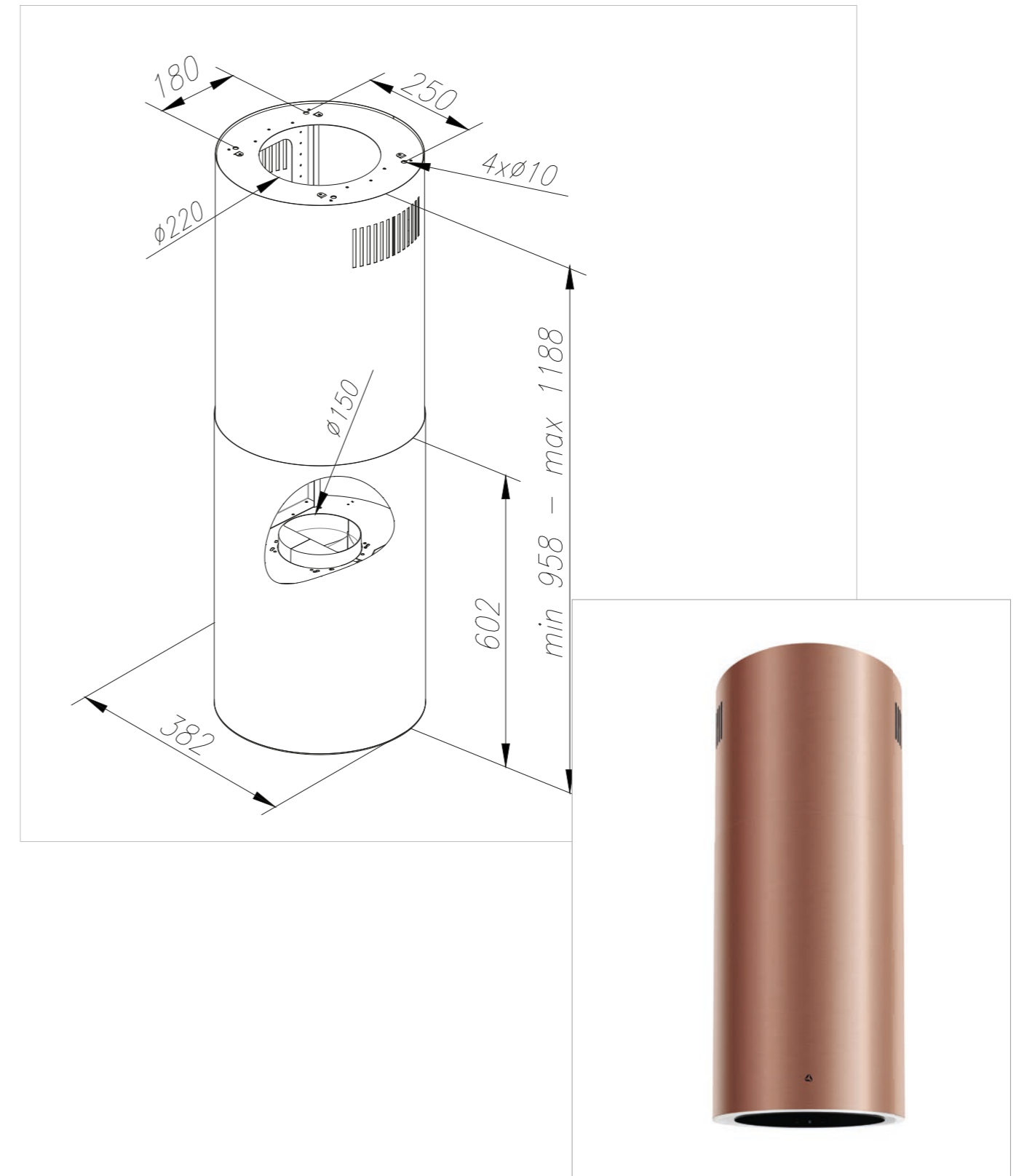







TUBUS W Long

TUBUS W Long

island hood

It is an **elongated version of the iconic cylinder**, designed for **high ceilings and spacious interiors**. Its **slim vertical silhouette** cuts through the space, creating a **dynamic decorative accent**. Despite its larger scale, the extractor retains its **visual lightness**, while delivering **enhanced vapour extraction performance**.

	Designed for high-ceiling interiors
	Warm2Cold lighting
	GestureControl
	BLDC motor
	Cook Assist

COLOR OPTIONS











TUBUS W LONG

island hood

Basic specifications

Hood type	Island
Dimensions (H x W x D)	1100-1475 x Ø382 mm
Airflow (min-max / boost)	160-370 (670) m ³ /h
Noise level (boost)	39-56(69) dB
Energy efficiency class	A+
Extraction mode	Extraction/Recirculation
Motor power	160 W
Lighting power	8 W
Lighting functions	Warm2Cold LED; adjustable intensity and colour temperature
Charcoal filter (type)	FWK228, Long Life 228
Charcoal filter included	No
Minimum distance from electric hob	45 cm
Minimum distance from gas hob	65 cm
Air outlet diameter	Ø 150
Control type	Gesture control
Speed levels	4
Alternative control	Control via induction hob, remote control
Rotatable motor	No
Hob-to-hood communication (Cook Assist)	Yes
External motor connection option (Outvent)	Yes
Net weight	22,3 kg
Adapt Flow technology	Yes

Technologies

								
Warm2ColdLED	GestureControl	Remote control	BLDC motor	Anti Fingerprint	Flexible installation	Cook Assist	Perimeter extraction	Adapt Flow

Technical drawing

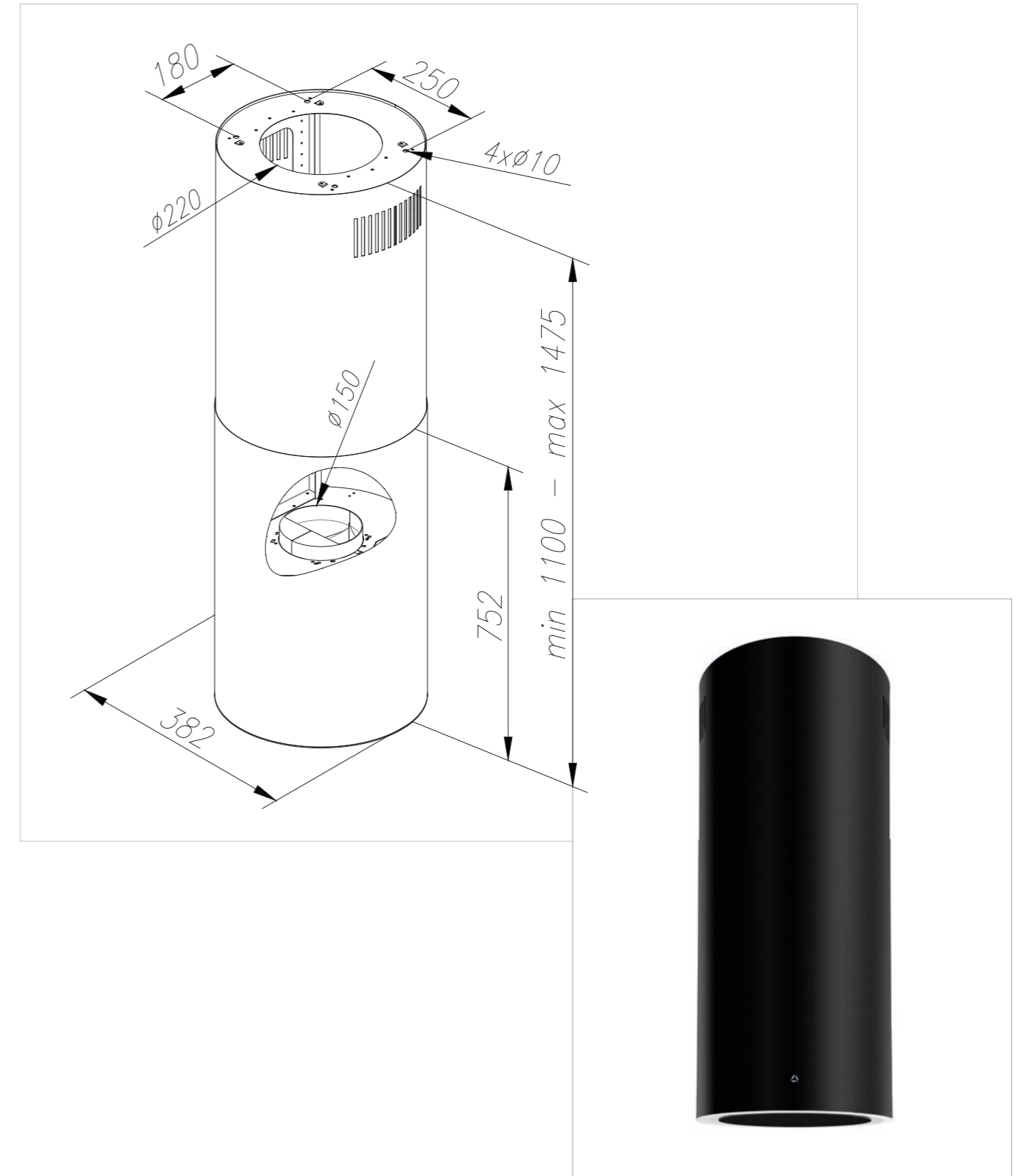







ROTO W

island hood

It **breaks away from sharp, geometric kitchen forms** with its **dynamic, rounded silhouette**, bringing a sense of **lightness and visual harmony** to the space. Its **aerodynamic design** and **advanced filtration system** ensure **crystal-clear air**, effectively preventing grease from settling on surrounding furniture and lighting.

With its **low noise level** and **wireless control via the hob**, it becomes an **exceptionally discreet and intelligent kitchen assistant**.



	Proprietary fluted surface
	Warm2Cold lighting
	GestureControl
	BLDC motor
	Cook Assist

COLOR OPTIONS



TEXTURE, UP CLOSE

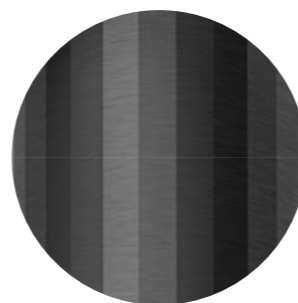











ROTO W

island hood

Basic specifications

Hood type	Island
Dimensions (H x W x D)	900 x 382 x 480 mm
Airflow (min-max / boost)	160-370 (670) m ³ /h
Noise level (boost)	39-56(69) dB
Energy efficiency class	A+
Ventilation type	Extraction/Recirculation
Motor power	160 W
Lighting power	8 W
Lighting functions	Warm2Cold LED; adjustable intensity and colour temperature
Charcoal filter (type)	FWK228, Long Life 228
Charcoal filter included	No
Minimum distance from electric hob	45 cm
Minimum distance from gas hob	65 cm
Air outlet diameter	Ø 150
Control type	Gesture control
Speed levels	4
Alternative control	Control via induction hob, remote control
Rotatable motor	No
Hob-to-hood communication (Cook Assist)	Yes
External motor connection option (Outvent)	Yes
Net weight	16 kg
Adapt Flow technology	Yes

Technologies

									
Warm2ColdLED	GestureControl	Remote control	BLDC motor	Anti Fingerprint	Flexible installation	Cook Assist	Fluted surface	Perimeter extraction	Adapt Flow

Technical drawing

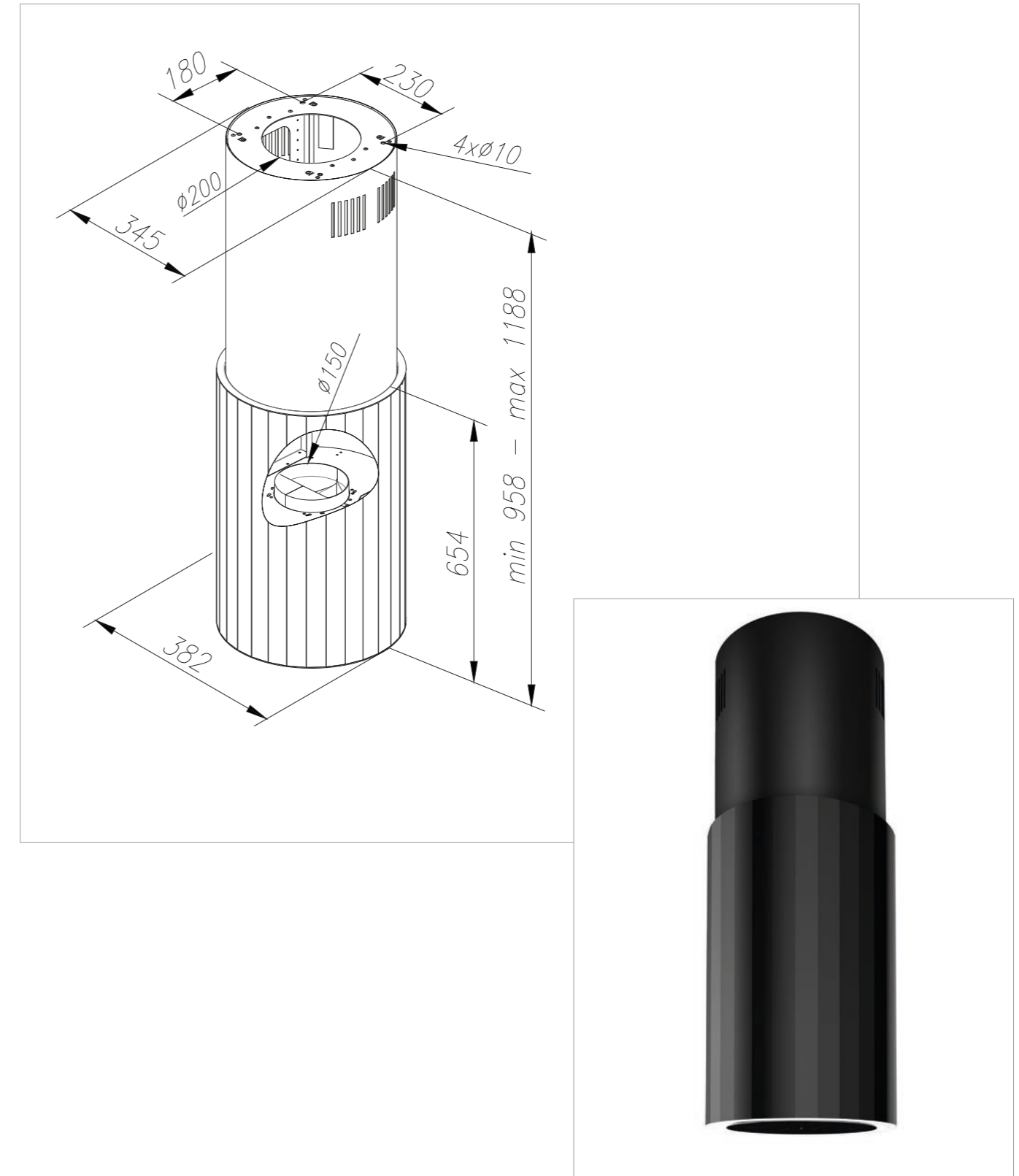



CUBE W





CUBE W

island hood

It is the **essence of modernist geometry**, available in a **rich colour palette** – from **deep black** to **bold, luxurious Rose Gold tones**. An **exceptionally quiet yet powerful A+++ turbine** efficiently handles **intense vapours**, using the **advanced AdaptFlow system** to perfectly match performance to the ventilation setup.

With **smooth light temperature adjustment**, the appliance blends seamlessly with the **main lighting of the living space**, ensuring the **perfect atmosphere and optimal visibility above the island**.



	Anti Fingerprint
	Warm2Cold lighting
	GestureControl
	BLDC motor
	Cook Assist

COLOR OPTIONS











CUBE W

island hood

Basic specifications

Hood type	Island
Dimensions (H x W x D)	975-1205 x 402 x 302 mm
Airflow (min-max / boost)	170-380 (680) m ³ /h
Noise level (boost)	40-57 (69) dB
Energy efficiency class	A+
Ventilation type	Extraction/Recirculation
Motor power	160 W
Lighting power	12 W
Lighting functions	Warm2Cold LED; adjustable intensity and colour temperature
Charcoal filter (type)	FWND185/V2
Charcoal filter included	No
Minimum distance from electric hob	45 cm
Minimum distance from gas hob	65 cm
Air outlet diameter	Ø 150
Control type	Gesture control
Speed levels	4
Alternative control	Control via induction hob, remote control
Rotatable motor	No
Hob-to-hood communication (Cook Assist)	Yes
External motor connection option (Outvent)	No
Net weight	20,5 kg
Adapt Flow technology	Yes

Technologies

								
Warm2ColdLED	GestureControl	Remote control	BLDC motor	Anti Fingerprint	Flexible installation	Cook Assist	Perimeter extraction	Adapt Flow

Technical drawing

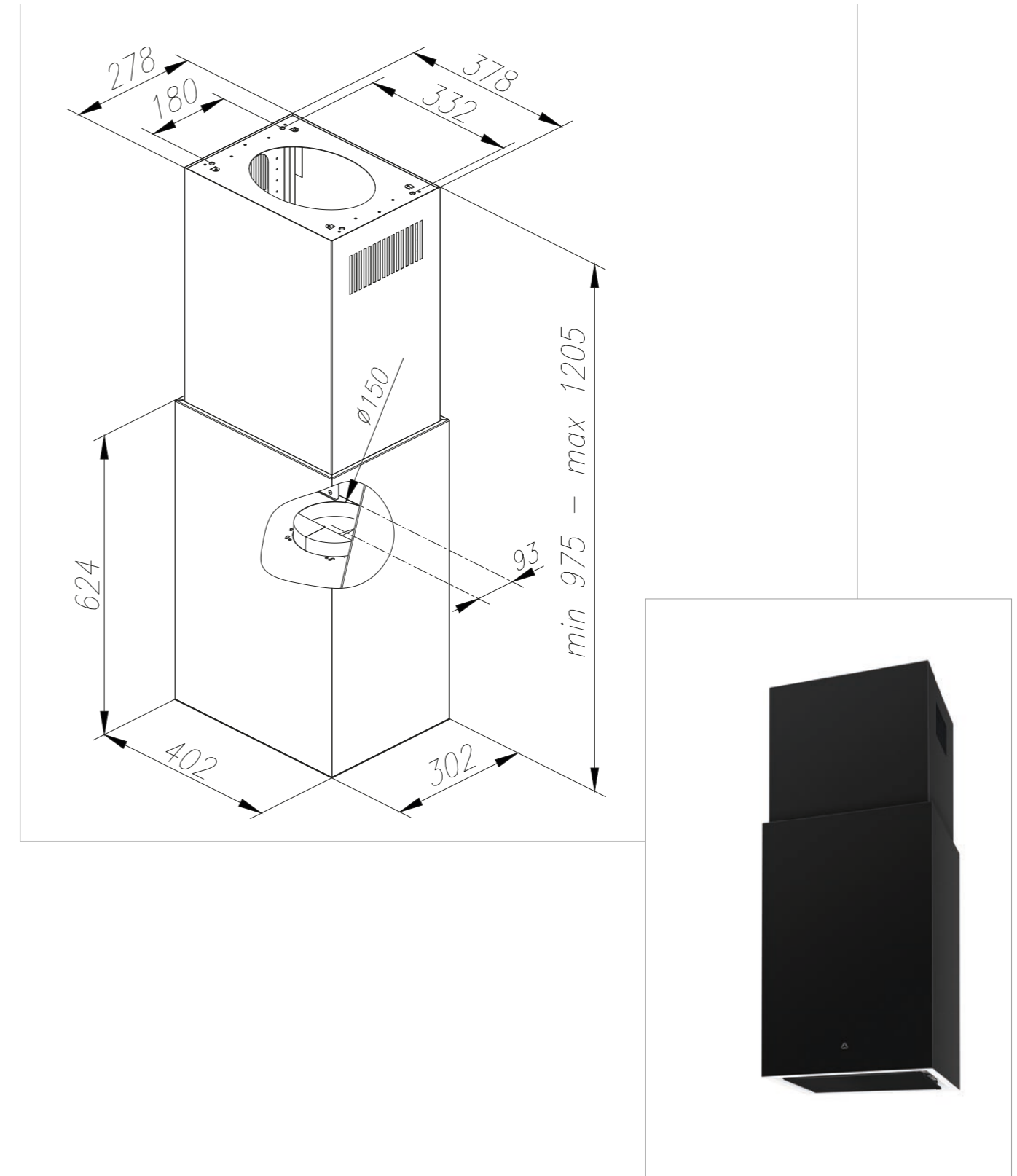







PIU LIGHT

PIU LIGHT

island hood

It is a **model inspired by pendant lighting**, floating above the kitchen island with **remarkable lightness and elegance**. Its panel LED lighting brings **more light into the space** without overwhelming it with its form.

It is an **ideal solution for open-plan kitchens**, where the extractor serves as both **ambient lighting** and a **high-performance air purification system**.

	Anti Fingerprint
	Warm2Cold lighting panel
	GestureControl
	BLDC motor
	Perimeter extraction

COLOR OPTIONS











PIU LIGHT

island hood

Basic specifications

Hood type	Island
Dimensions (H x W x D)	60 cm - 2856 x Ø 600 mm 80 cm - 2856 x Ø 800 mm
Airflow (min-max / boost)	60 cm - 100-240 (480) m³/h 80 cm - 180-360 (640) m³/h
Noise level (boost)	60 cm - 43-57 (70) dB 80 cm - 41-56 (67) dB
Energy efficiency class	A++
Ventilation type	Recirculation
Motor power	60 cm - 169 W 74 cm - 171 W
Lighting power	60 cm - 9 W 74 cm - 11 W
Lighting functions	Warm2Cold LED; adjustable intensity and colour temperature
Charcoal filter (type)	Filtr Long Life M/P
Charcoal filter included	Yes
Minimum distance from electric hob	45 cm
Minimum distance from gas hob	65 cm
Air outlet diameter	No
Control type	Gesture control
Speed levels	4
Alternative control	Remote control
Rotatable motor	No
Hob-to-hood communication (Cook Assist)	Yes
External motor connection option (Outvent)	No
Net weight	60 cm - 18,3 kg 80 cm - 25,9 kg
Adapt Flow technology	Yes

Technologies

							
Warm2ColdLED	GestureControl	Remote control	BLDC motor	Anti Fingerprint	Flexible installation	Panel lighting	Perimeter extraction

Technical drawing

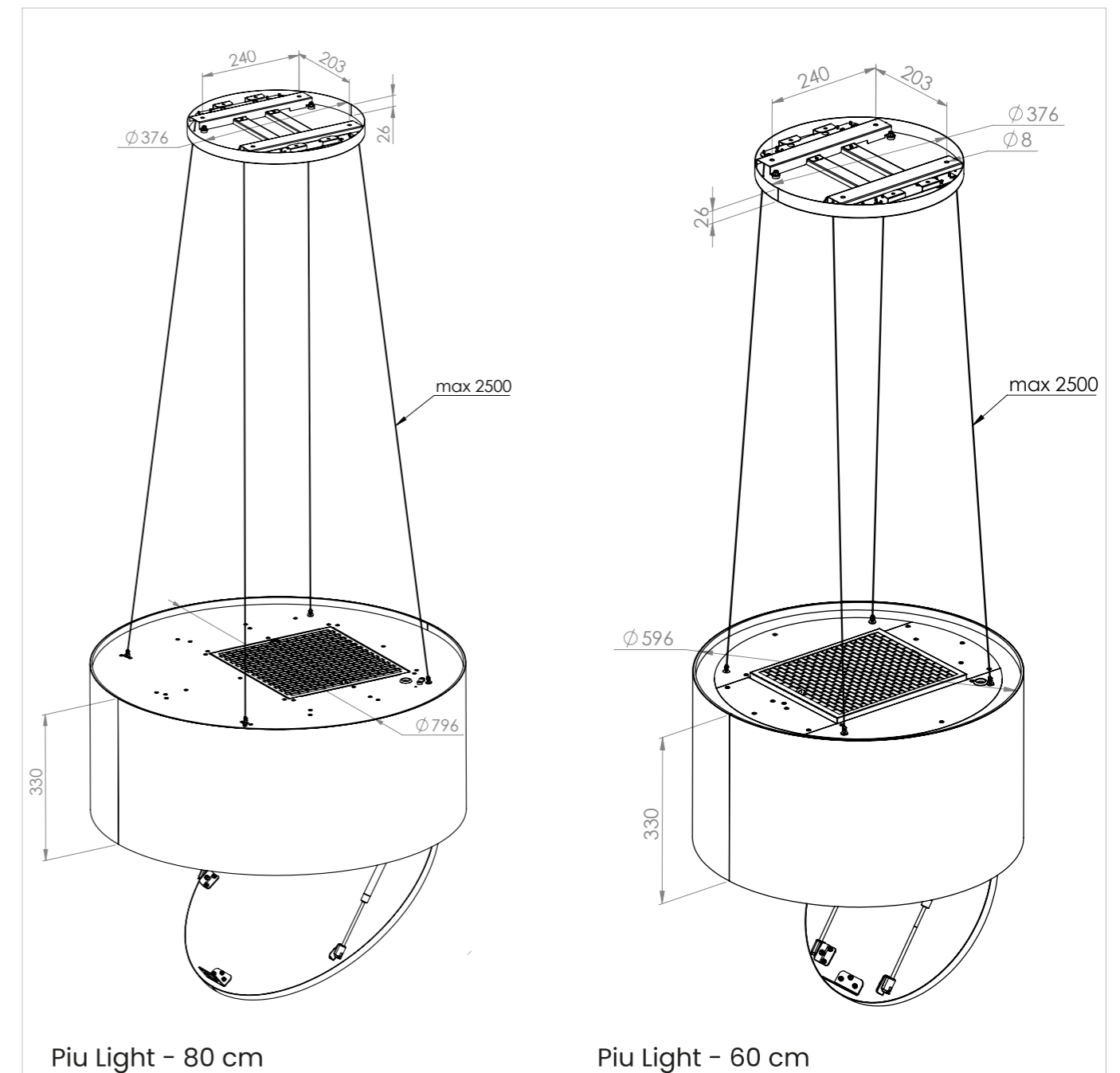



MONO LIGHT





MONO LIGHT

island hood

It is an **evolution of the classic Mono form**, enhanced with a **spectacular lighting module** that adds a **distinctive glow to the kitchen**. The **fluted design** is balanced by **soft ambient light**, which becomes the **main decorative feature after dark**.

This model combines the **raw character of industrial design** with the **function of atmospheric lighting**, creating a **warm and inviting ambience at the heart of the home**.



	Proprietary fluted surface
	Warm2Cold lighting panel
	GestureControl
	BLDC motor
	Perimeter extraction

COLOR OPTIONS



TEXTURE, UP CLOSE











MONO LIGHT

island hood

Basic specifications

Hood type	Island
Dimensions (H x W x D)	60 cm - 2856 x Ø 600 mm 80 cm - 2856 x Ø 800 mm
Airflow (min-max / boost)	60 cm - 100-240 (480) m³/h 80 cm - 180-360 (640) m³/h
Noise level (boost)	60 cm - 43-57 (70) dB 80 cm - 41-56 (67) dB
Energy efficiency class	A++
Ventilation type	Recirculation
Motor power	60 cm - 169 W 74 cm - 171 W
Lighting power	60 cm - 9 W 74 cm - 11 W
Lighting functions	Warm2Cold LED; adjustable intensity and colour temperature
Charcoal filter (type)	Filtr Long Life M/P
Charcoal filter included	Yes
Minimum distance from electric hob	45 cm
Minimum distance from gas hob	65 cm
Air outlet diameter	No
Control type	Gesture control
Speed levels	4
Alternative control	Remote control
Rotatable motor	No
Hob-to-hood communication (Cook Assist)	Yes
External motor connection option (Outvent)	No
Net weight	60 cm - 18,3 kg 80 cm - 25,9 kg
Adapt Flow technology	Tak

Technologies

								
Warm2ColdLED	GestureControl	Remote control	BLDC motor	Anti Fingerprint	Flexible installation	Panel lighting	Fluted surface	Perimeter extraction

Technical drawing

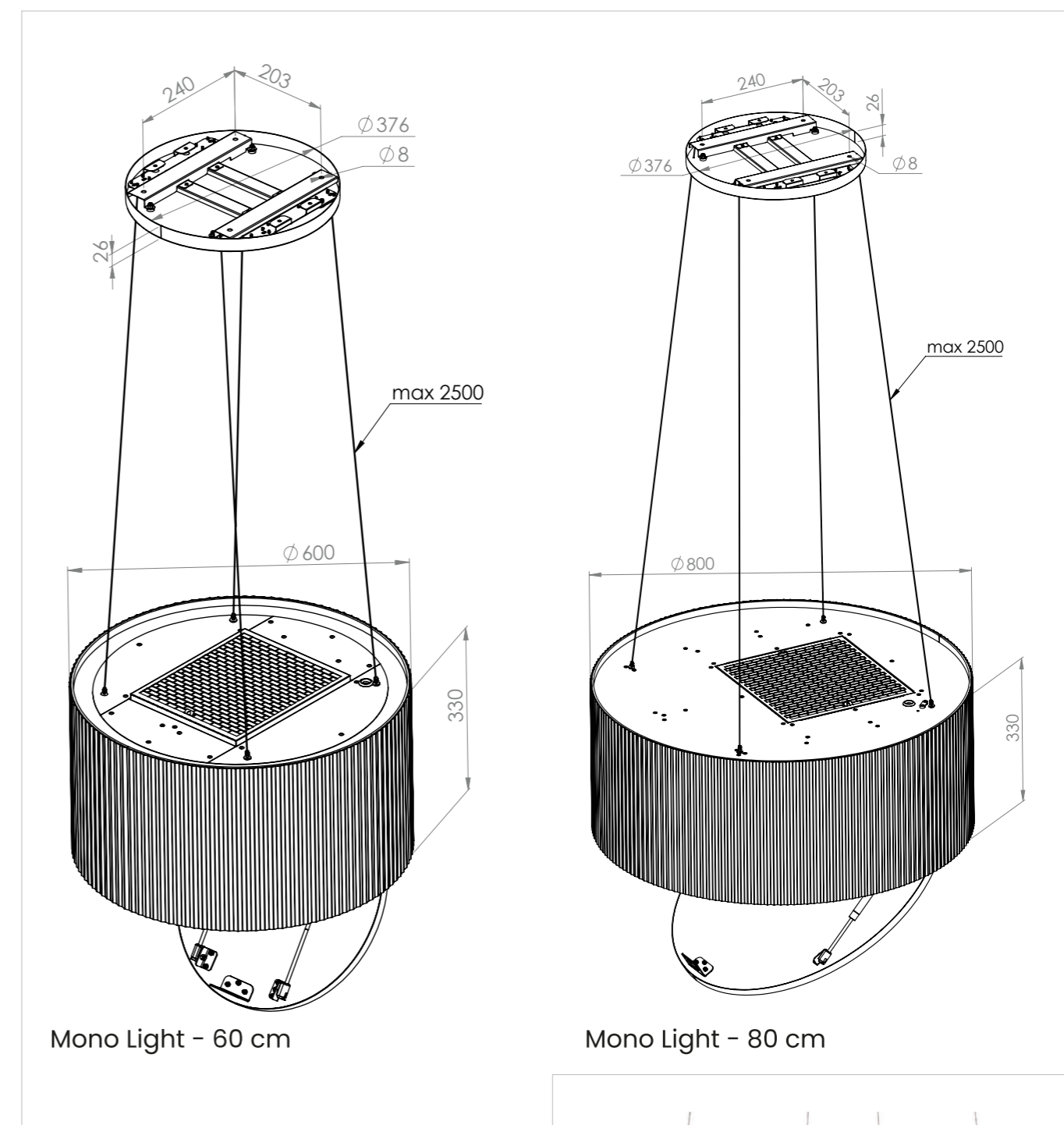

Mono Light - 60 cm

Mono Light - 80 cm



05

**INTEGRATED
COOKER
HOODS**



integrated cooker hoods





DISCREET ELEGANCE AND INTELLIGENT FUNCTIONALITY,
PERFECTLY SUITED TO MODERN, MINIMALIST INTERIORS

UNO

integrated cooker hoods

It stands out with a **fully concealed design** and an **advanced 360° perimeter extraction system**. Operation is handled via an **intuitive GestureControl system**, allowing you to **adjust extraction power with a simple hand movement**, without touching the appliance.

The **energy-efficient A++ BLDC motor** delivers **powerful extraction performance** with **minimal energy consumption** and **near-silent operation**.

	Warm2Cold lighting
	GestureControl
	BLDC motor
	Cook Assist
	Perimeter extraction

COLOR OPTIONS











UNO

integrated cooker hoods

Basic specifications

Hood type	Undercabinet hood
Dimensions (H × W × D)	55 cm - 265 x 551 x 290 mm
	74 cm - 265 x 740 x 290 mm
Airflow (min-max / boost)	55 cm - 190-445 (705) m ³ /h
	74 cm - 210-475 (740) m ³ /h
Noise level (boost)	55 cm - 39-57 (68) dB
	74 cm - 40-58 (68) dB
Energy efficiency class	A++
Ventilation type	Extraction/Recirculation
Motor power	160 W
Lighting power	8 W
Lighting functions	Warm2Cold LED; adjustable intensity and colour temperature
Charcoal filter (type)	FWK385 / FWK485
Charcoal filter included	No
Minimum distance from electric hob	45 cm
Minimum distance from gas hob	65 cm
Air outlet diameter	Ø 150
Control type	Gesture control
Speed levels	4
Alternative control	Control via induction hob, remote control
Rotatable motor	Yes
Hob-to-hood communication (Cook Assist)	Yes
External motor connection option (Outvent)	Yes
Net weight	55 cm - 8,05 kg
	74 cm - 10,5 kg
Adapt Flow technology	Yes

Technologies

							
Warm2ColdLED	GestureControl	Remote control	Silnik BLDC	Flexible installation	Cook Assist	Perimeter extraction	Adapt Flow

Technical drawing

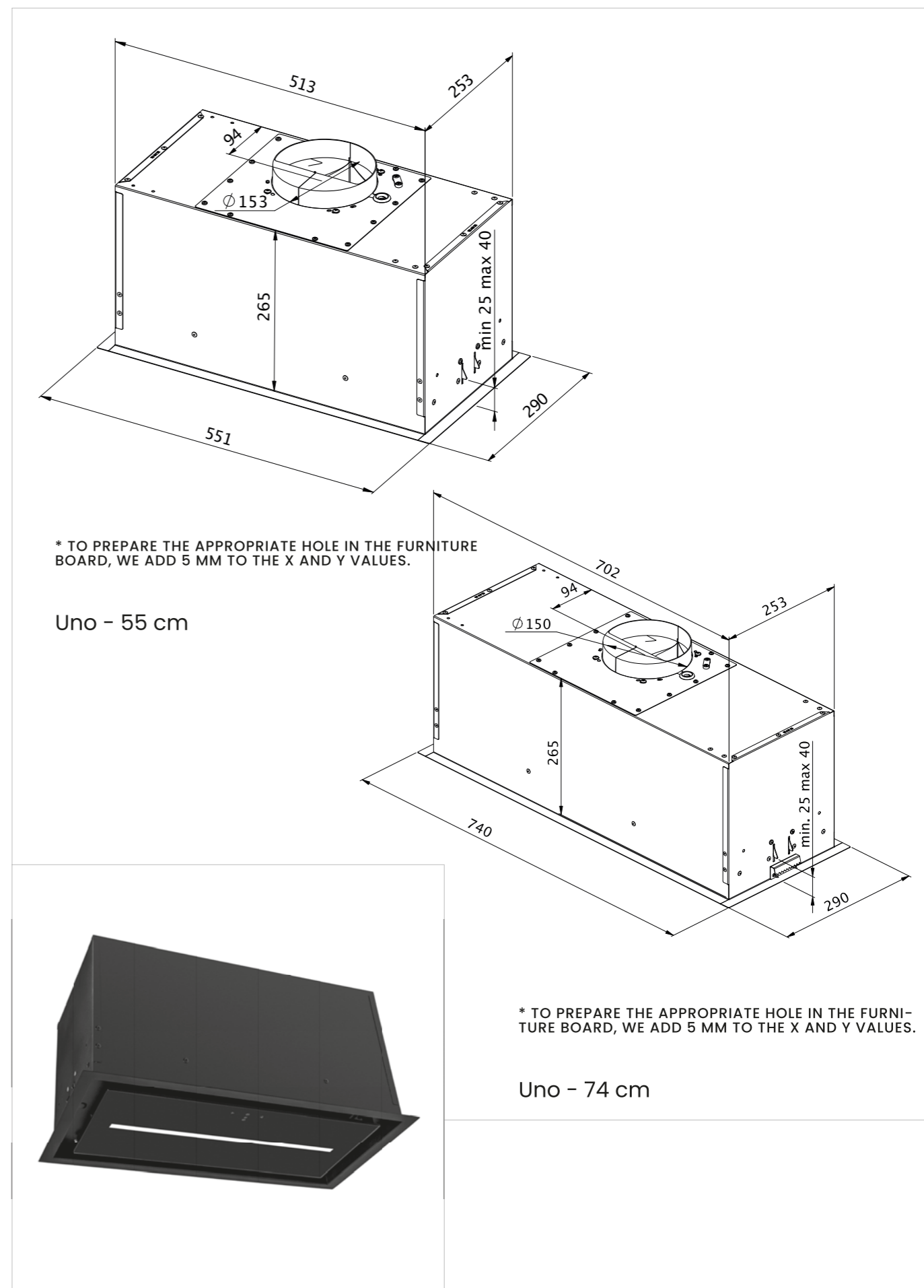





DUO

integrated cooker hoods

It is an **advanced built-in cabinet model** that proves a **discreet appliance can deliver powerful performance**. Equipped with **gesture control** and **hob synchronization**, it enables **fully automatic operation without touching the cabinet front**.

Thanks to its **space-saving design**, the unit takes up **minimal space inside the cabinet**, leaving **extra room for storing spices**.

	Warm2Cold lighting
	GestureControl
	BLDC motor
	Cook Assist
	Perimeter extraction

COLOR OPTIONS











DUO

integrated cooker hoods

Basic specifications

Hood type	Undercabinet hood
Dimensions (H × W × D)	55 cm - 265 x 551 x 290 mm
	74 cm - 265 x 740 x 290 mm
Airflow (min-max / boost)	55 cm - 190-445 (710) m ³ /h
	74 cm - 210-475 (740) m ³ /h
Noise level (boost)	55 cm - 39-57 (68) dB
	74 cm - 40-58 (68) dB
Energy efficiency class	55 cm - A+
	74 cm - A++
Ventilation type	Extraction/Recirculation
Motor power	160 W
Lighting power	8 W
Lighting functions	Warm2Cold LED; adjustable intensity and colour temperature
Charcoal filter (type)	FWK385, FWK485
Charcoal filter included	No
Minimum distance from electric hob	45 cm
Minimum distance from gas hob	65 cm
Air outlet diameter	Ø 150
Control type	Gesture control
Speed levels	4
Alternative control	Control via induction hob, remote control
Rotatable motor	No
Hob-to-hood communication (Cook Assist)	Yes
External motor connection option (Outvent)	Yes
Net weight	55 cm - 8,05 kg
	74 cm - 10,5 kg
Adapt Flow technology	Yes

Technologies

							
Warm2ColdLED	GestureControl	Remote control	Silnik BLDC	Flexible installation	Cook Assist	Perimeter extraction	Adapt Flow

Technical drawing

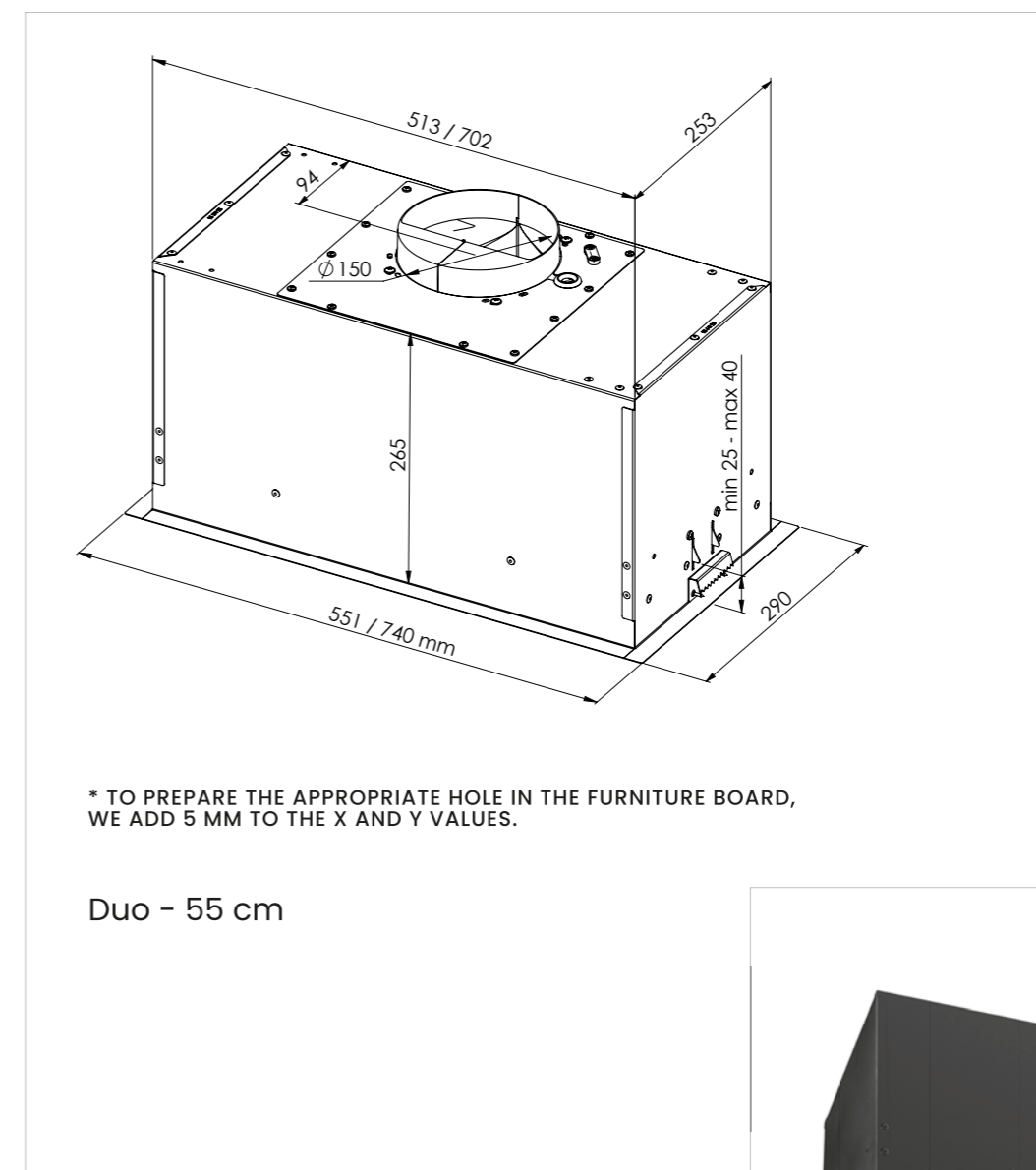

Duo - 55 cm







SU MINI

integrated cooker hoods

It is a **master of space optimisation**, with a **concealed** that saves **up to 20% of valuable cabinet space**. Despite its **compact dimensions**, it features a **powerful and energy-efficient motor**, effectively removing odours even in heavily used kitchens.

The **GestureControl module** allows for **quick and seamless adjustment of operating modes** with a simple hand movement in the air.

	Warm2Cold lighting
	GestureControl
	BLDC motor
	Cook Assist
	Panel lighting

COLOR OPTIONS













SU MINI

integrated cooker hoods

Basic specifications

Hood type	Undercabinet hood
Dimensions (H × W × D)	55 cm - 320 x 600 x 310 mm 74 cm - 320 x 740 x 290 mm
Airflow (min-max / boost)	55 cm - 185-380 (680) m ³ /h 74 cm - 195-380 (690) m ³ /h
Noise level (boost)	55 cm - 42-58 (69) dB 74 cm - 42-58 (69) dB
Energy efficiency class	A++
Ventilation type	Extraction/Recirculation
Motor power	160 W
Lighting power	6 W
Lighting functions	Warm2Cold LED; adjustable intensity and colour temperature
Charcoal filter (type)	FWN185/V2, 60 cm - Long Life 467 / 74 cm - Long Life 485
Charcoal filter included	No
Minimum distance from electric hob	45 cm
Minimum distance from gas hob	65 cm
Air outlet diameter	Ø 150
Control type	Gesture control
Speed levels	4
Alternative control	Control via induction hob, remote control
Rotatable motor	Yes
Hob-to-hood communication (Cook Assist)	Yes
External motor connection option (Outvent)	Yes
Net weight	55 cm - 9,1 kg 74 cm - 12 kg
Adapt Flow technology	Yes

Technologies

									
Warm2ColdLED	GestureControl	Remote control	Silnik BLDC	Flexible installation	Cook Assist	Panel lighting	Rotatable motor	Perimeter extraction	Adapt Flow

Technical drawing

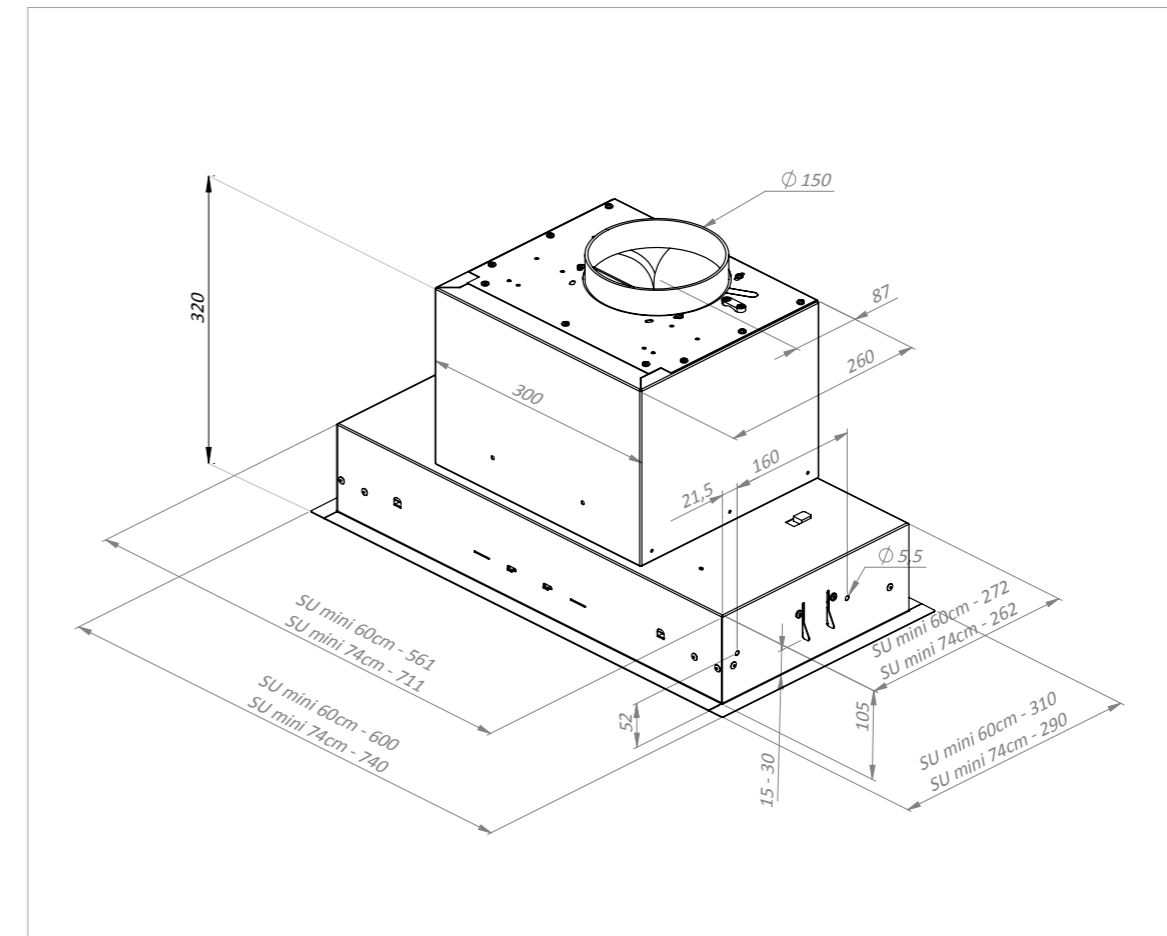

* TO PREPARE THE APPROPRIATE HOLE IN THE FURNITURE BOARD, WE ADD 5 MM TO THE X AND Y VALUES.

Su Mini - 55 cm / 74 cm





AURA

integrated cooker hoods

It stands out with a **glass bottom surface**, giving the entire form a sense of **lightness and refined brilliance**. This fully glass underside becomes the core design feature, creating a **smooth, easy-to-clean plane** that sits perfectly flush with modern cabinetry.

Thanks to this finish, the extractor not only **efficiently captures vapours**, but also becomes an **elegant detail**, subtly reflecting light above the cooking area.

	Warm2Cold lighting
	GestureControl
	BLDC motor
	Cook Assist
	Perimeter extraction











AURA

integrated cooker hoods

Basic specifications

Hood type	Undercabinet hood
Dimensions (H x W x D)	55 cm - 281 x 550 x 290 mm 74 cm - 281 x 740 x 290 mm
Airflow (min-max / boost)	55 cm - 185-380 (680) m ³ /h 74 cm - 195-380 (690) m ³ /h
Noise level (boost)	55 cm - 42-58 (69) dB 74 cm - 42-58 (69) dB
Energy efficiency class	A++
Ventilation type	Extraction/Recirculation
Motor power	160 W
Lighting power	6 W
Lighting functions	Warm2Cold LED; adjustable intensity and colour temperature
Charcoal filter (type)	FWK385, FWK485
Charcoal filter included	No
Minimum distance from electric hob	45 cm
Minimum distance from gas hob	65 cm
Air outlet diameter	Ø 150
Control type	Gesture control
Speed levels	4
Alternative control	Control via induction hob, remote control
Rotatable motor	Yes
Hob-to-hood communication (Cook Assist)	Yes
External motor connection option (Outvent)	Yes
Net weight	55 cm - 8,2 kg 74 cm - 9,2 kg
Adapt Flow technology	Yes

Technologies

								
Warm2ColdLED	GestureControl	Remote control	BLDC motor	Flexible installation	Cook Assist	Rotatable motor	Perimeter extraction	Adapt Flow

Technical drawing

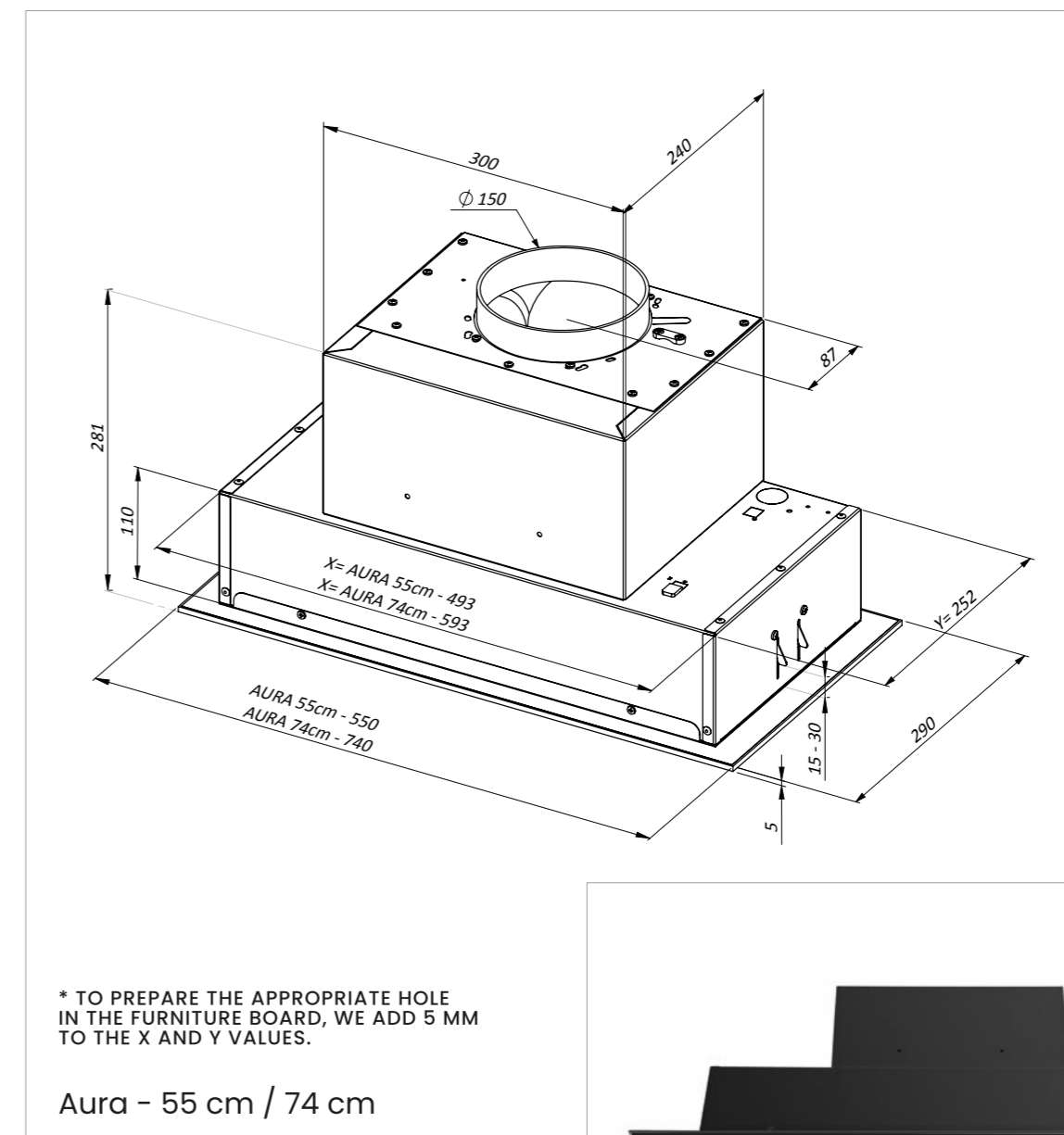





MINIMAL 7

integrated cooker hoods

It is an **advanced built-in cabinet model** that proves a **discreet appliance can deliver powerful performance**. Equipped with **gesture control** and **hob synchronization**, it enables **fully automatic operation without touching the cabinet front**.

Thanks to its **space-saving design**, the unit takes up **minimal space inside the cabinet**, leaving **extra room for storing spices**.

	Warm2Cold lighting
	GestureControl
	BLDC motor
	Cook Assist
	Filtry Baffle

COLOR OPTIONS











MINIMAL 7

integrated cooker hoods

Basic specifications

Hood type	Undercabinet hood
Dimensions (H × W × D)	55 cm - 320 x 550 x 290 mm
	74 cm - 281 x 740 x 290 mm
	90 cm - 320 x 900 x 290 mm
Airflow (min-max / boost)	55 cm - 170-390 (650) m ³ /h
	74 cm - 180-400 (660) m ³ /h
	90 cm - 185-410 (670) m ³ /h
Noise level (boost)	55 cm - 42-58 (69) dB
	74 cm - 42-58 (69) dB
	90 cm - 42-58 (69) dB
Energy efficiency class	A++
Ventilation type	Extraction/Recirculation
Motor power	160 W
Lighting power	6 W
Lighting functions	Warm2Cold LED; adjustable intensity and colour temperature
Charcoal filter (type)	FWN185/V2
Charcoal filter included	No
Minimum distance from electric hob	45 cm
Minimum distance from gas hob	65 cm
Air outlet diameter	Ø 150
Control type	Gesture control
Speed levels	4
Alternative control	Remote control
Rotatable motor	Yes
Hob-to-hood communication (Cook Assist)	No
External motor connection option (Outvent)	Yes
Net weight	55 cm - 8,2 kg
	74 cm - 9,2 kg
	90 cm - 10,5 kg
Adapt Flow technology	Yes

Technologies

							
Warm2ColdLED	GestureControl	Remote control	BLDC motor	Flexible installation	Filtr Baffle	Reversible motor	Adapt Flow

Technical drawing

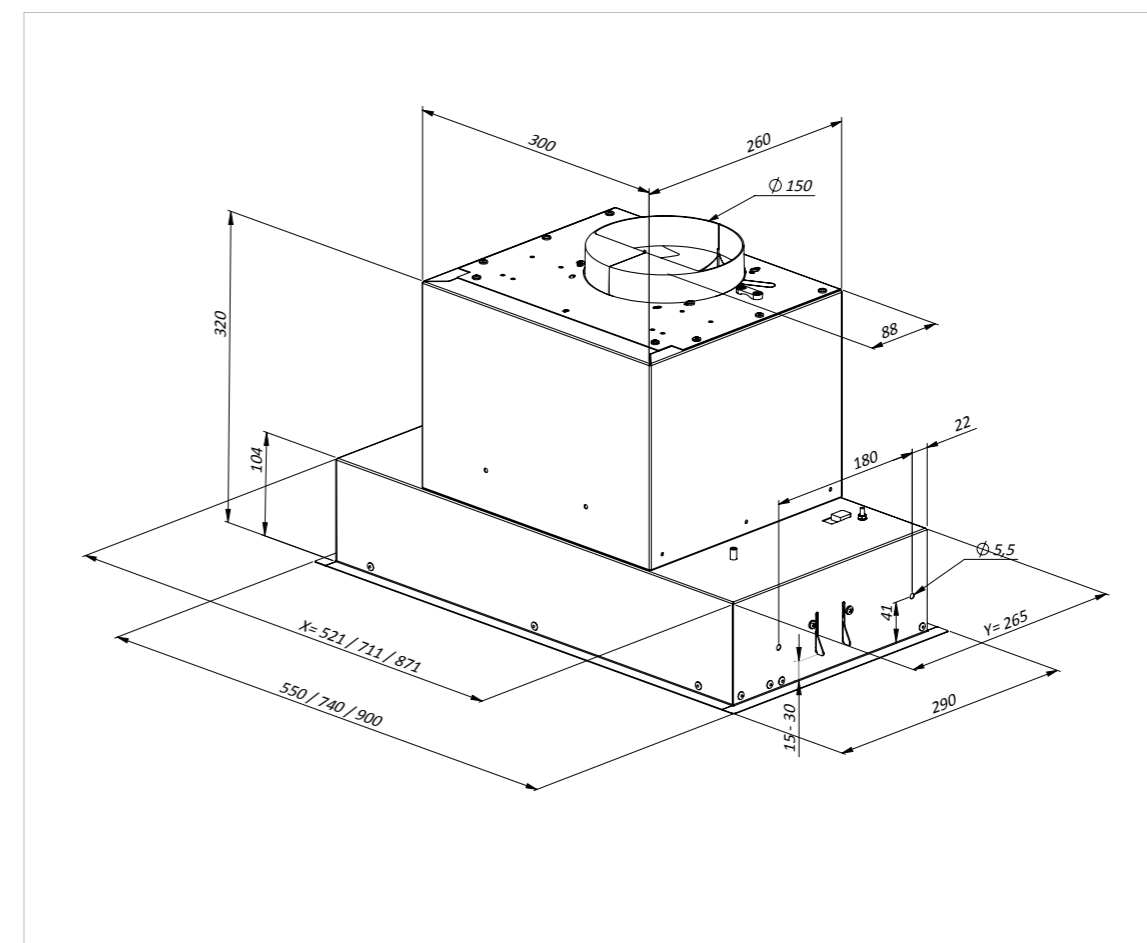

* TO PREPARE THE APPROPRIATE HOLE IN THE FURNITURE BOARD, WE ADD 5 MM TO THE X AND Y VALUES.

Minimal 7 - 55 cm / 74 cm / 90 cm





JOKER UNO

integrated cooker hoods

It is an **advanced built-in cabinet** model that proves a **discreet appliance can deliver powerful performance**. Equipped with **gesture control** and **hob synchronization**, it enables **fully automatic operation without touching the cabinet front**.

Thanks to its **space-saving design**, the unit takes up **minimal space inside the cabinet**, leaving **extra room for storing spices**.

	Warm2Cold lighting
	GestureControl
	BLDC motor
	Cook Assist
	System SpaceMax Joker

COLOR OPTIONS

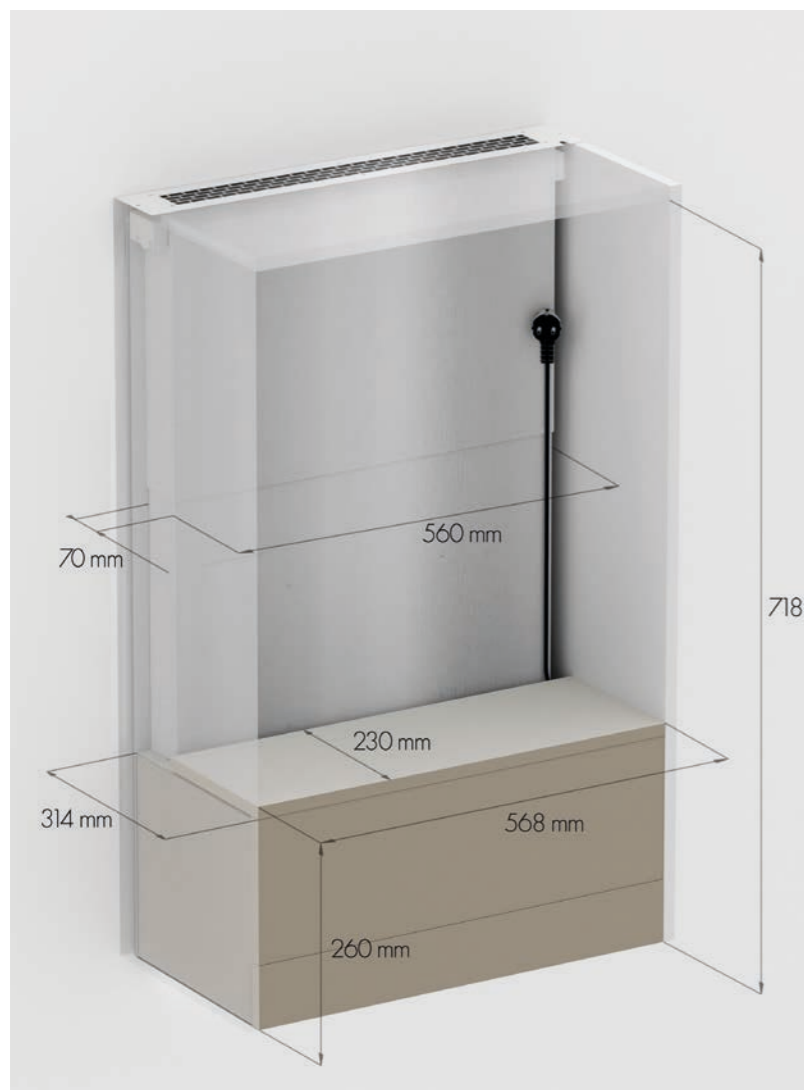









JOKER UNO

integrated cooker hoods

Basic specifications

Hood type	Undercabinet hood
Dimensions (H x W x D)	55 cm - 241 x 550 x 290 mm 74 cm - 241 x 740 x 290 mm
Airflow (min-max / boost)	55 cm - 160-355 (650) m ³ /h 74 cm - 170-365 (660) m ³ /h
Noise level (boost)	55 cm - 38-55 (68) dB 74 cm - 38-55 (68) dB
Energy efficiency class	A
Ventilation type	Extraction/Recirculation
Motor power	160 W
Lighting power	55 cm - 6 W, 74 cm - 7 W
Lighting functions	Warm2Cold LED; adjustable intensity and colour temperature
Charcoal filter (type)	FWK385, FWK485
Charcoal filter included	Nie
Minimum distance from electric hob	45 cm
Minimum distance from gas hob	65 cm
Air outlet diameter	220 x 90 mm
Control type	Gesture control
Speed levels	4
Alternative control	Control via induction hob, remote control
Rotatable motor	No
Hob-to-hood communication (Cook Assist)	Yes
External motor connection option (Outvent)	No
Net weight	55 cm - 11,3 kg 74 cm - 13,7 kg
Adapt Flow technology	Yes

Technologies

								
Warm2ColdLED	GestureControl	Remote control	BLDC motor	Flexible installation	Cook Assist	Perimeter extraction	Adapt Flow	SpaceMax Joker system

Technical drawing

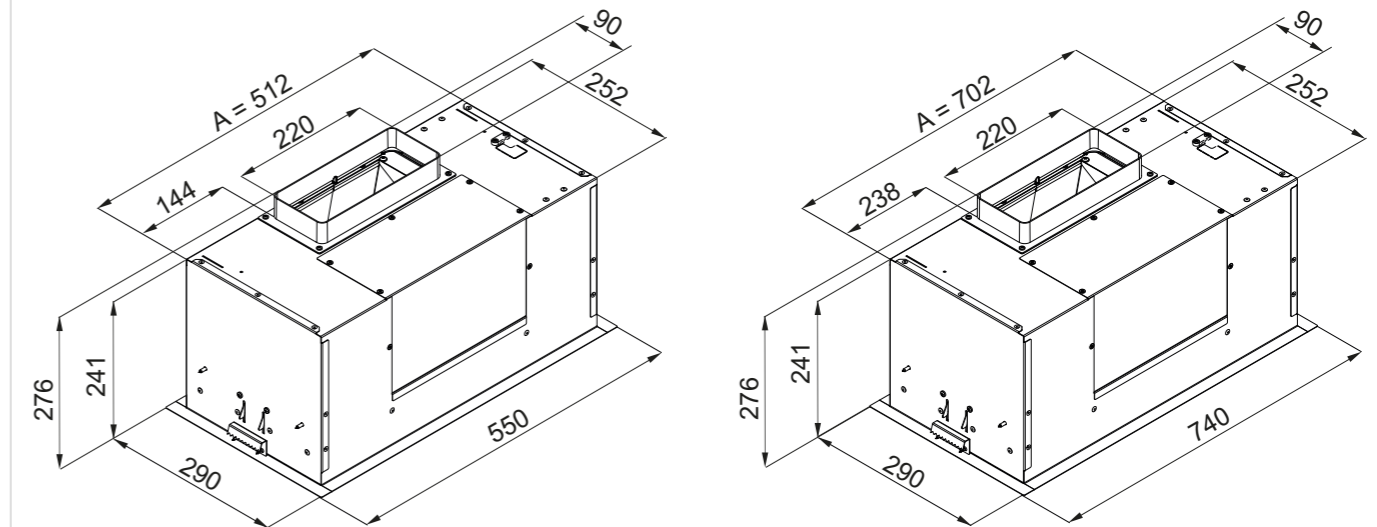

* TO PREPARE THE APPROPRIATE HOLE IN THE FURNITURE BOARD, WE ADD 5 MM TO THE X AND Y VALUES.

Joker Uno 55 cm / 74 cm

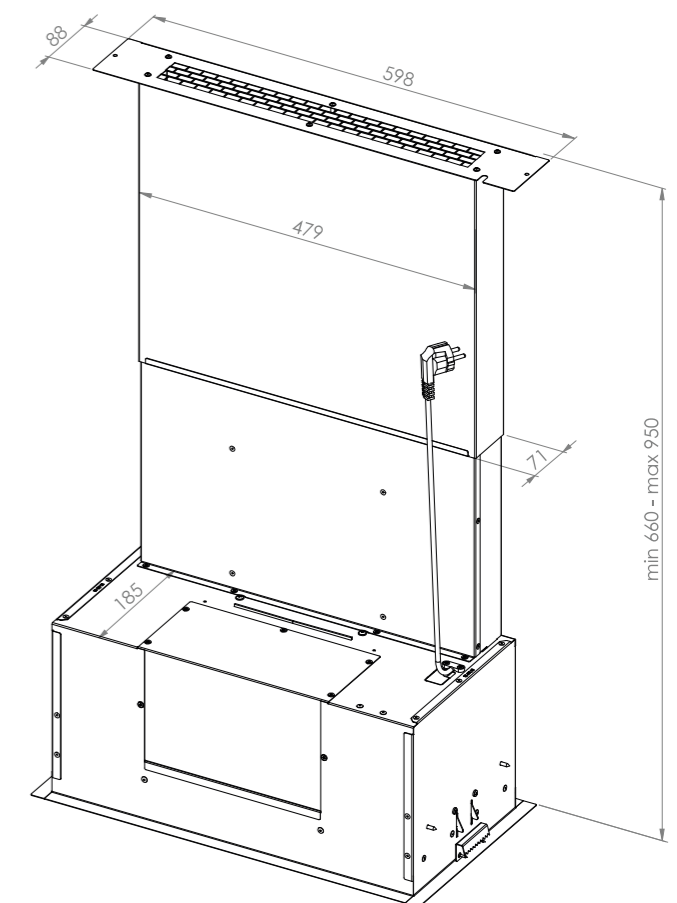





* TO PREPARE THE APPROPRIATE HOLE IN THE FURNITURE BOARD, WE ADD 5 MM TO THE X AND Y VALUES.

JOKER DUO

integrated cooker hoods

It is an **advanced built-in cabinet model** that proves a **discreet appliance can deliver powerful performance**. Equipped with **gesture control** and **hob synchronization**, it enables **fully automatic operation without touching the cabinet front**.

Thanks to its **space-saving design**, the unit takes up **minimal room inside the cabinet**, leaving **additional space for spice storage**.

	Warm2Cold lighting
	GestureControl
	BLDC motor
	Cook Assist
	System SpaceMax Joker

COLOR OPTIONS

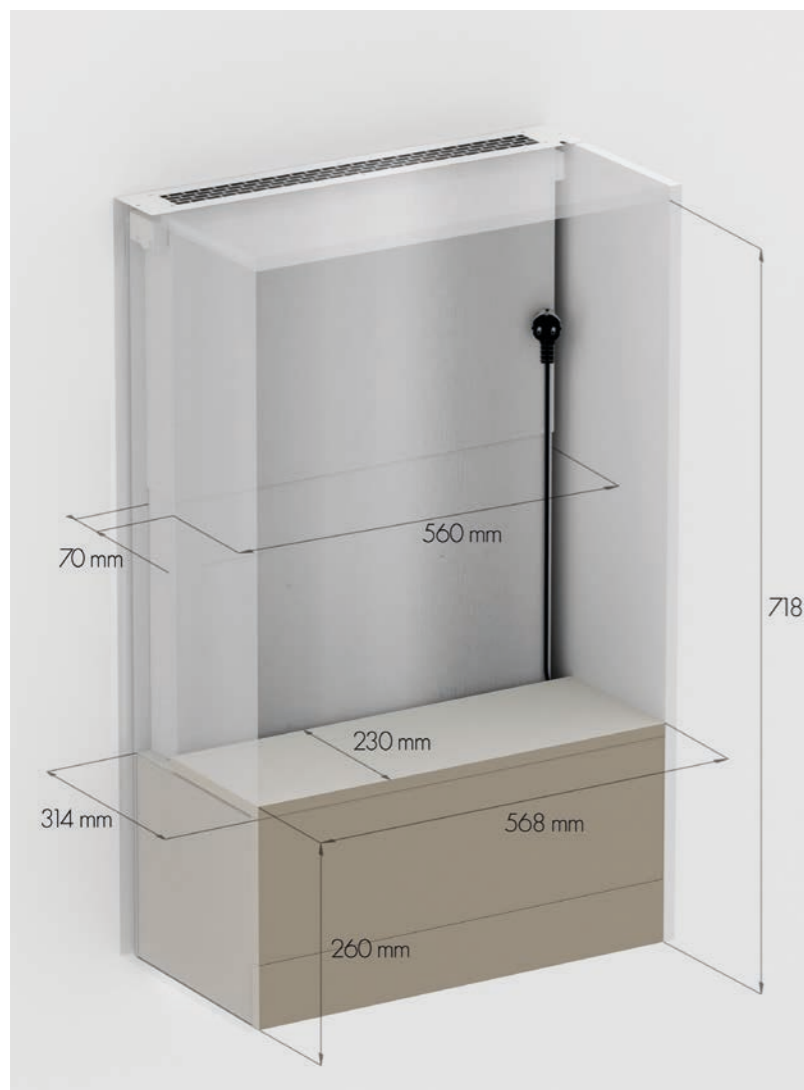









JOKER DUO

integrated cooker hoods

Basic specifications

Hood type	Undercabinet hood
Dimensions (H x W x D)	55 cm - 281 x 550 x 290 mm 74 cm - 281 x 740 x 290 mm
Airflow (min-max / boost)	55 cm - 185-380 (680) m ³ /h 74 cm - 195-380 (690) m ³ /h
Noise level (boost)	55 cm - 42-58 (69) dB 74 cm - 42-58 (69) dB
Energy efficiency class	A++
Ventilation type	Extraction/Recirculation
Motor power	160 W
Lighting power	8 W
Lighting functions	Warm2Cold LED; adjustable intensity and colour temperature
Charcoal filter (type)	FWK385, FWK485
Charcoal filter included	No
Minimum distance from electric hob	45 cm
Minimum distance from gas hob	65 cm
Air outlet diameter	220 x 90 mm
Control type	Gesture control
Speed levels	4
Alternative control	Control via induction hob, remote control
Rotatable motor	Yes
Hob-to-hood communication (Cook Assist)	Yes
External motor connection option (Outvent)	Yes
Net weight	55 cm - 8,2 kg 74 cm - 9,2 kg
Adapt Flow technology	Yes

Technologies

								
Warm2ColdLED	GestureControl	Remote control	BLDC motor	Flexible installation	Cook Assist	Perimeter extraction	Adapt Flow	SpaceMax Joker system

Technical drawing

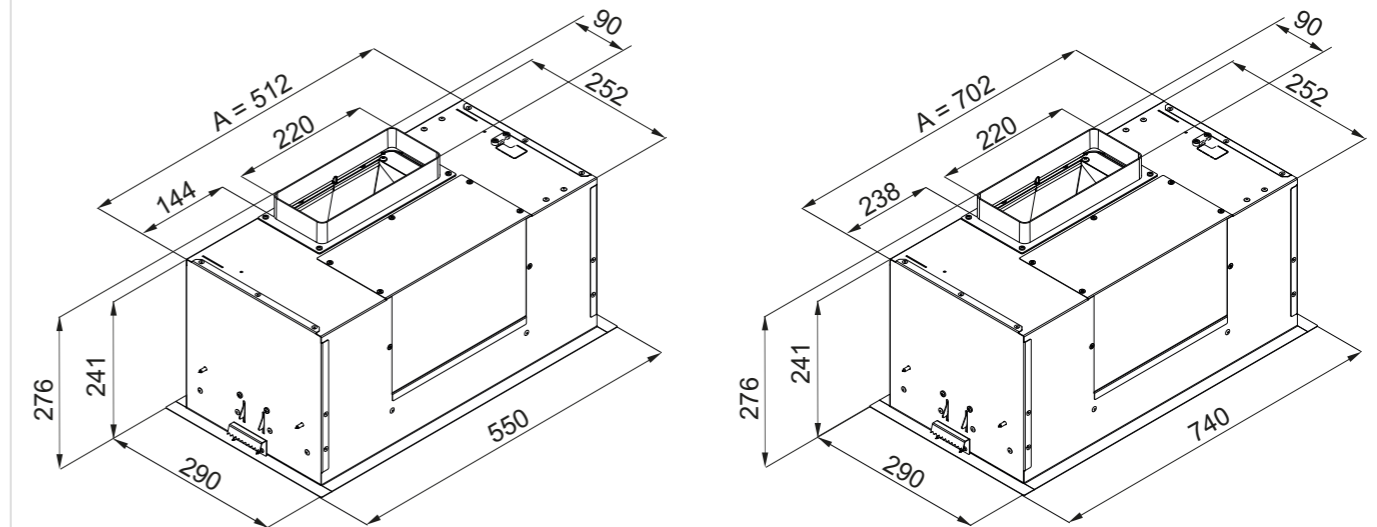

* TO PREPARE THE APPROPRIATE HOLE IN THE FURNITURE BOARD, WE ADD 5 MM TO THE X AND Y VALUES.

Joker Duo 55 cm / 74 cm

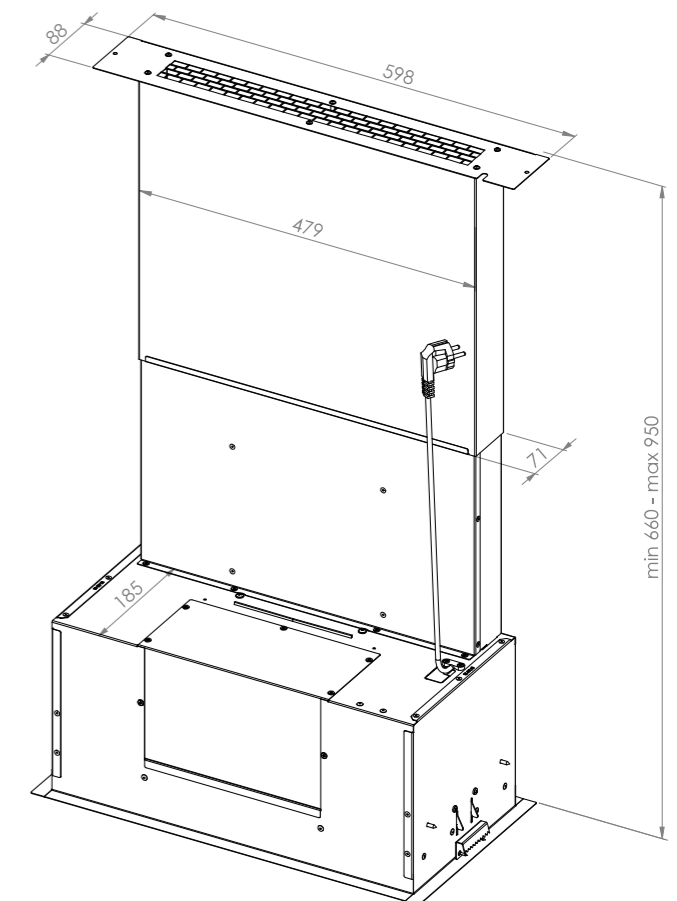





SET: UNO/DUO HOOD + SPACEMAX JOKER PLUS SYSTEM

LUNO

integrated cooker hoods

It is an **advanced built-in cabinet model** that proves a **discreet appliance can deliver powerful performance**. Equipped with **gesture control** and **hob synchronization**, it enables **fully automatic operation without touching the cabinet front**.

Thanks to its **space-saving design**, the unit takes up **minimal room inside the cabinet**, leaving **extra storage space for spices**.

	Warm2Cold lighting
	GestureControl
	BLDC motor
	Cook Assist
	Perimeter extraction

COLOR OPTIONS











LUNO

integrated cooker hoods

Basic specifications

Hood type	Undercabinet hood
Dimensions (H × W × D)	52 cm - 261 x 520 x 282 mm
	72 cm - 261 x 720 x 282 mm
Airflow (min-max / boost)	52 cm - 130-355 (615) m ³ /h
	72 cm - 160-385 (685) m ³ /h
Noise level (boost)	52 cm - 38-60 (70) dB
	72 cm - 38-58 (69) dB
Energy efficiency class	52 cm - A+
	72 cm - A++
Ventilation type	Extraction/Recirculation
Motor power	160 W
Lighting power	7 W
Lighting functions	Warm2Cold LED; adjustable intensity and colour temperature
Charcoal filter (type)	FWN185/V2
Charcoal filter included	No
Minimum distance from electric hob	45 cm
Minimum distance from gas hob	65 cm
Air outlet diameter	Ø 150
Control type	Soft-touch buttons
Speed levels	4
Alternative control	Control via induction hob, remote control
Rotatable motor	No
Hob-to-hood communication (Cook Assist)	Yes
External motor connection option (Outvent)	No
Net weight	55 cm - 8,05 kg
	74 cm - 10,5 kg
Adapt Flow technology	No

Technologies

							
Warm2ColdLED	Precise control	BLDC motor	Flexible installation	Cook Assist	Reversible motor	Adapt Flow	Air Refresh Function

Technical drawing

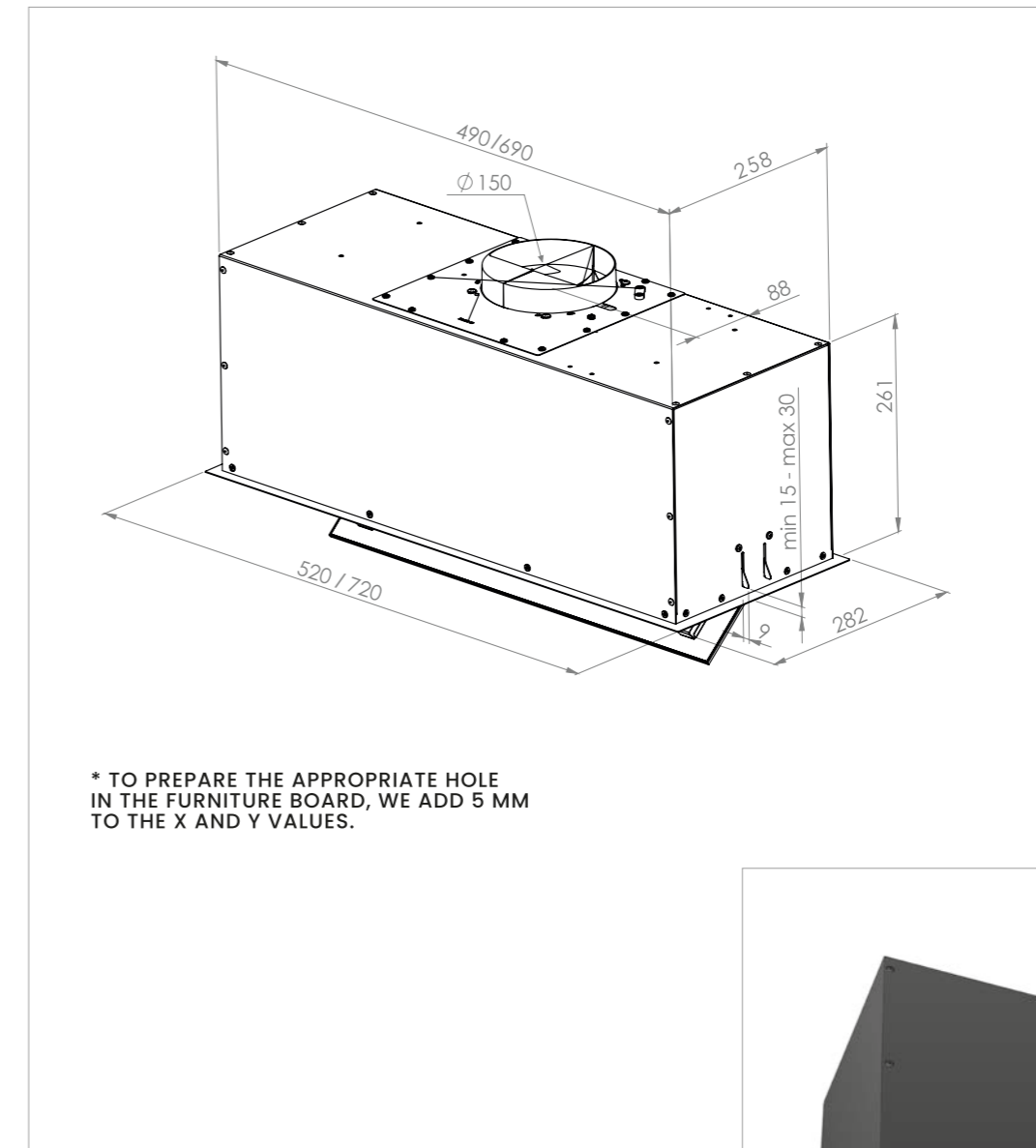

06

**CEILING
HOODS**

ceiling hood

A PREMIUM MINIMALIST SOLUTION THAT ENSURES
MAXIMUM DESIGN FREEDOM AND VISUAL CLARITY OF THE SPACE







SU LIGHT

ceiling hood

It shares its **outstanding structural performance** and an **ultra-slim, space-saving motor** with its counterpart from the **Frame series**. What sets it apart is a **large central LED panel**, which **floods the entire kitchen island with powerful, uniform light**, effectively replacing the main ceiling fixture.

The combination of **minimalist design discreetly integrated into a suspended ceiling** and **convenient remote control** ensures **complete cooking comfort without obstructing the field of view**.

	Warm2Cold lighting
	Panel lighting
	BLDC motor
	Rotatable motor
	Installation in suspended ceilings

COLOR OPTIONS









SU LIGHT

ceiling hood

Basic specifications

Hood type	Ceiling
Dimensions (H x W x D)	190x900x600 mm
Airflow (min-max / boost)	190-475 (750) m ³ /h
Noise level (boost)	44-64 (70) dB
Energy efficiency class	A
Ventilation type	Extraction
Motor power	170 W
Lighting power	10 W
Lighting functions	Warm2Cold LED; adjustable intensity and colour temperature
Charcoal filter (type)	No
Charcoal filter included	No
Minimum distance from electric hob	No
Minimum distance from gas hob	No
Air outlet diameter	220 x 90 mm
Control type	Remote control
Speed levels	4
Alternative control	No
Rotatable motor	Yes
Hob-to-hood communication (Cook Assist)	No
External motor connection option (Outvent)	Yes
Net weight	22,7 kg
Adapt Flow technology	No

Technologies

						
Warm2ColdLED	Perimeter lighting	Remote control	BLDC motor	Rotatable motor	Perimeter extraction	Installation in suspended ceilings

Technical drawing

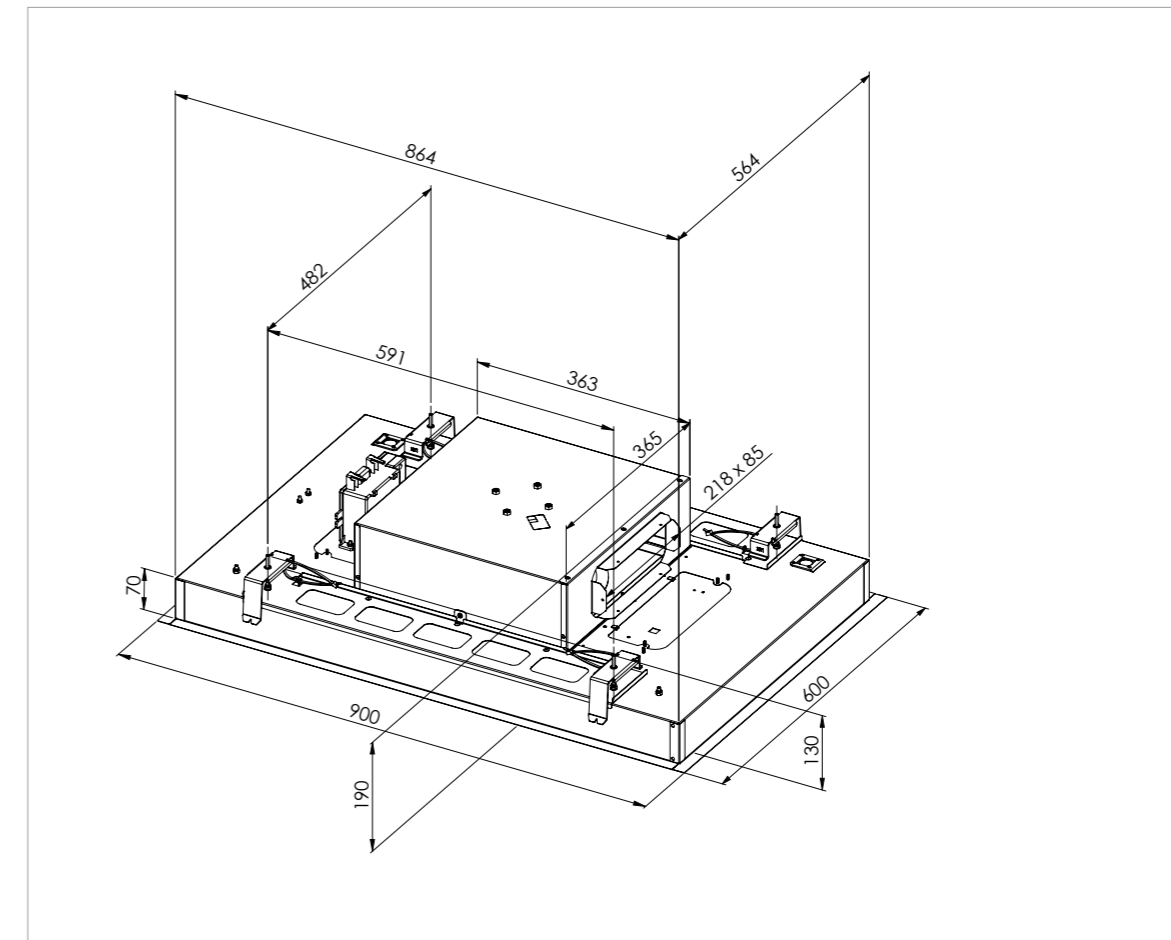

* TO PREPARE THE APPROPRIATE HOLE IN THE FURNITURE BOARD, WE ADD 5 MM TO THE X AND Y VALUES.







SU FRAME

ceiling hood

It is an **innovative ceiling extractor that redefines open space in the kitchen**, reducing its installation height to just **19 cm** thanks to an **ultra-slim motor**. The model features a **unique perimeter lighting panel hidden just above the glass panel**, creating a **striking, atmospheric effect** over the cooking area.

By utilising the **Venturi effect** and an **advanced 360° suction chamber**, it significantly enhances vapour **extraction efficiency**, combining **discreet design** with an **exceptional A energy rating**.

	Warm2Cold lighting
	Perimeter lighting
	BLDC motor
	Rotatable motor
	Installation in suspended ceilings

COLOR OPTIONS









SU FRAME

ceiling hood

Basic specifications

Hood type	Ceiling
Dimensions (H x W x D)	190x900x600 mm
Airflow (min-max / boost)	190-475 (750) m ³ /h
Noise level (boost)	44-64 (70) dB
Energy efficiency class	A
Ventilation type	Extraction
Motor power	170 W
Lighting power	10 W
Lighting functions	Warm2Cold LED; adjustable intensity and colour temperature
Charcoal filter (type)	No
Charcoal filter included	No
Minimum distance from electric hob	No
Minimum distance from gas hob	No
Air outlet diameter	220 x 90 mm
Control type	Remote control
Speed levels	4
Alternative control	No
Rotatable motor	Yes
Hob-to-hood communication (Cook Assist)	No
External motor connection option (Outvent)	Yes
Net weight	20 kg
Adapt Flow technology	No

Technologies

						
Warm2ColdLED	Perimeter lighting	Remote control	BLDC motor	Rotatable motor	Perimeter extraction	Installation in suspended ceilings

Technical drawing

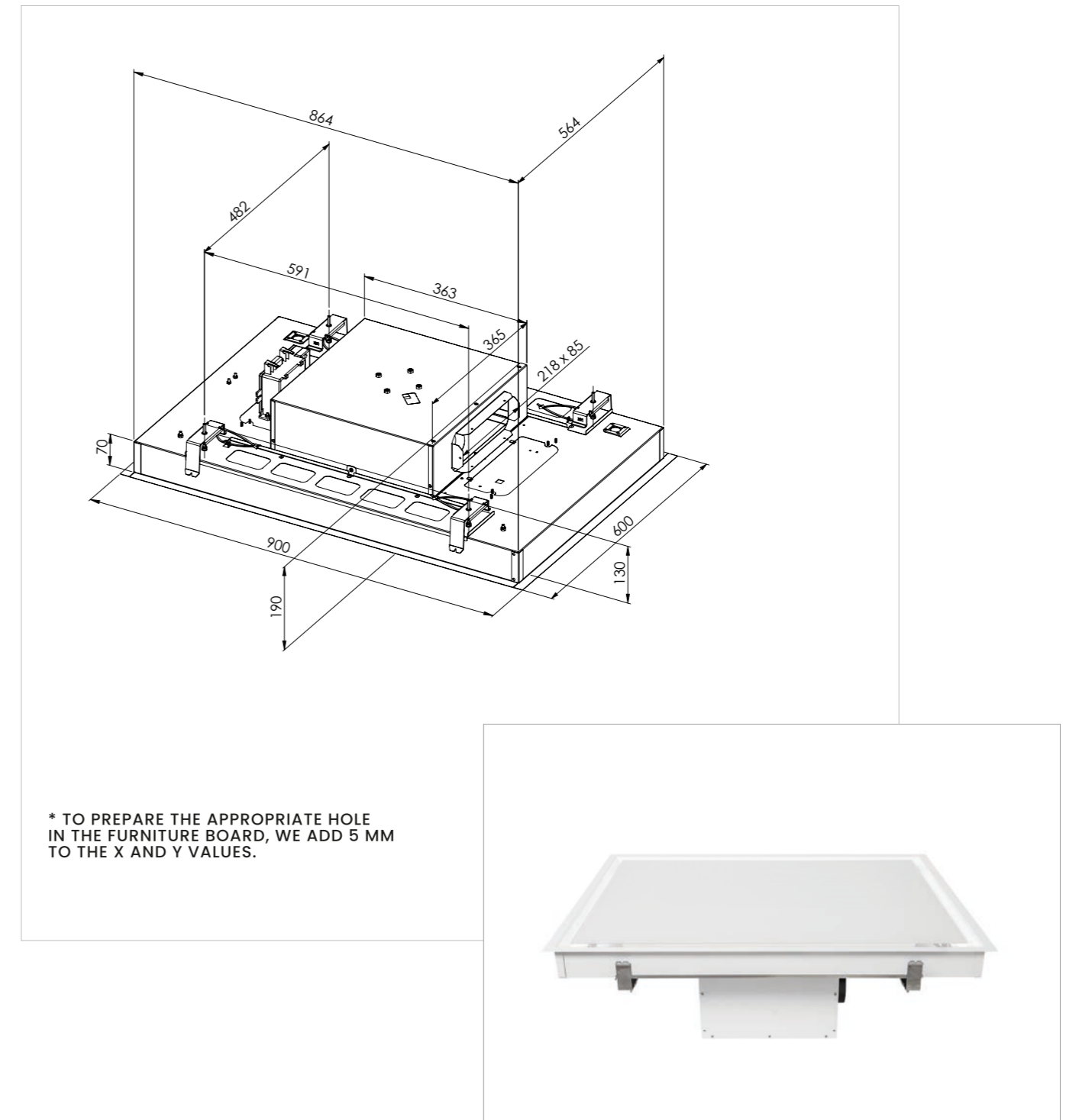

04

DOWNDRAFT

downdraft

INNOVATIVE TECHNOLOGY HIDDEN WITHIN THE WORKTOP,
DELIVERING LUXURIOUS AESTHETICS AND ULTIMATE USER COMFORT.







MOONDRAFT

Moondraft

countertop hood

This is an **exclusive downdraft extractor** concealed within a dedicated housing, which **elegantly rises up to an impressive height of 50 cm during operation**. It features a **precision mechanism with anti-pinch sensors** and a **high-performance motor that can be fully relocated away from the working area**. Operation of this remarkable extractor is easily controlled via an **aesthetic and intuitive touch display seamlessly integrated into the glass surface**.

	Flush installation
	BLDC motor – quiet operation and energy efficiency
	Rotatable motor
	Extractor extends up to 50 cm
	External motor connection option



Moondraft

countertop hood

Basic specifications

Dimensions (H × W × D)	60 cm - 723+500 x 598 x 333 mm
	90 cm - 723+500 x 898 x 380 mm
Airflow (min-max / boost)	60 cm - 220-480 (670) m ³ /h
	90 cm - 305-640 (730) m ³ /h
Noise level (boost)	60 cm - 51-65 (69) dB
	90 cm - 52-65 (67) dB
Extension range	50cm
Finish	Matte black / black glass
Lighting	LED
Energy class	60 cm - A
	90 cm - B
Motor power	60 cm - 275 W
	90 cm - 278 W
Lighting power	60 cm - 8 W
	90 cm - 10 W
Power cable length	2 m
Carbon filter model	FWK280, Filtr Long Life 150
Carbon filter included	No
Carbon filter installation method	Mounted on the grease filter
Air outlet diameter	Ø 150
Control	Touch control
Speed levels	3
Motor rotation option	Yes
Weight	60 cm - 28 kg
	90 cm - 35 kg

Technologies

BLDC motor	Rotatable motor	Extractor extends up to 50 cm	Flush installation	External OUT motor connection option

Technical drawing

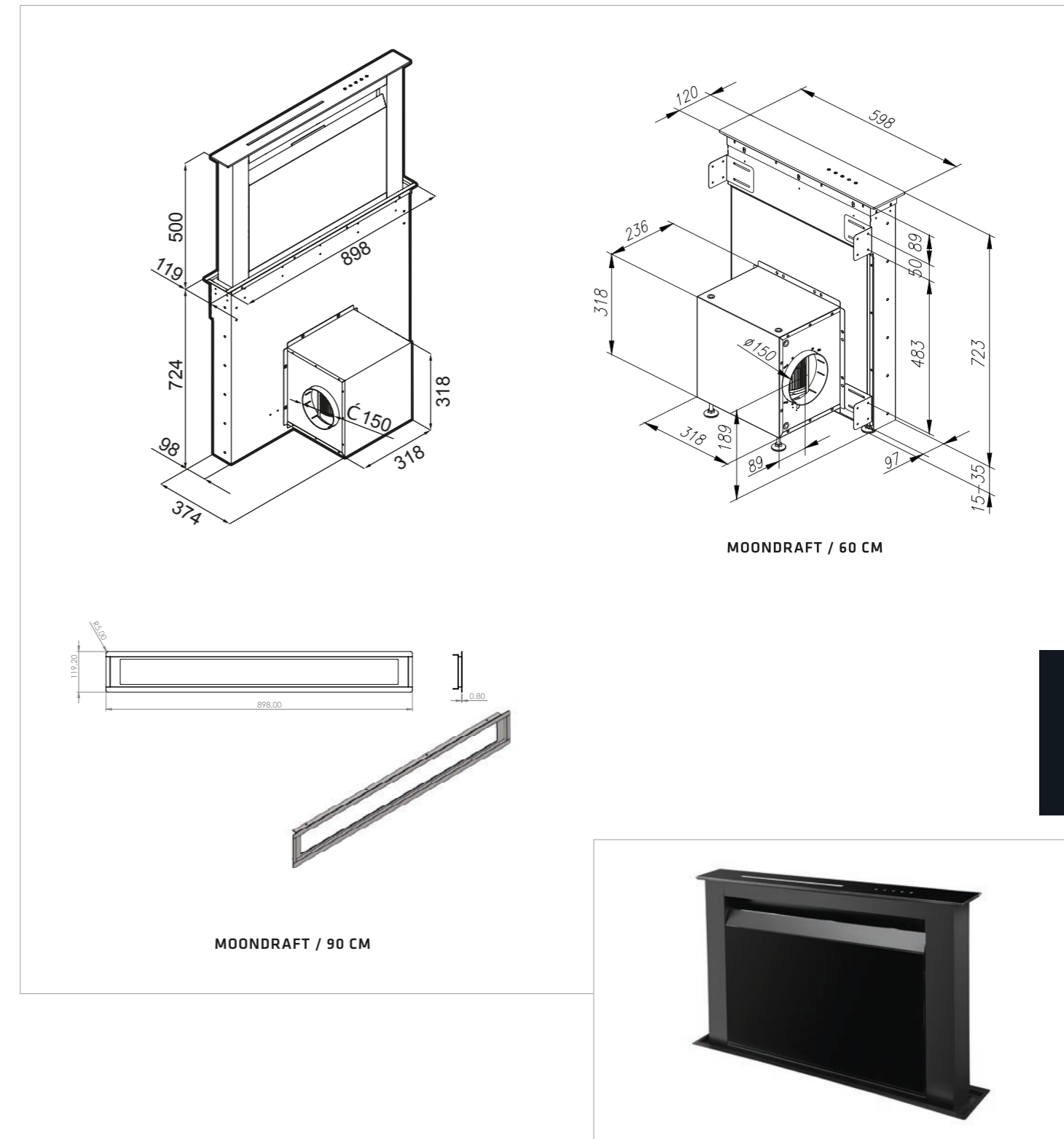

07

**INDUCTION
HOBS**



induction hob





THE ESSENCE OF MODERN TECHNOLOGY,
COMBINING COOKING PRECISION WITH ELEGANT, MINIMALIST DESIGN.



CulinaSync Advanced

induction hob

It combines **intuitive control** with **innovative features**, such as **precise temperature maintenance**, ideal for **melting chocolate** or **slowly simmering sauces**. The hob communicates **wirelessly with Monno extractors**, automatically adjusting extraction power to the intensity of cooking. The option for **flush installation** enhances the **modern look of the interior** and makes everyday cleaning easier.

	Flush installation
	Slider
	Cook Assist
	Bridge
	Boost









CulinaSync Advanced

induction hob

Basic specifications

Dimensions (H x W x D)	65 x 600 x 515 mm
Number of cooking zones	4
Total power	7200 W
Zone power	3x 2000 W, 1x 1600 W
Bridge zones	Yes, 1x
User safety	Button lock, Child Lock
Automatic cooking programs	Yes
Cook Assist – automatic extractor control	Yes
Timer	Yes
Boost	Yes
Flush installation	Yes
Control type	Touch control, 1x slider
Control color	Red
Finish	Glossy black
Net weight	8,25 kg

Technologies

					
Flush installation	Touch display	Cook Assist	Timer	Bridge	Boost



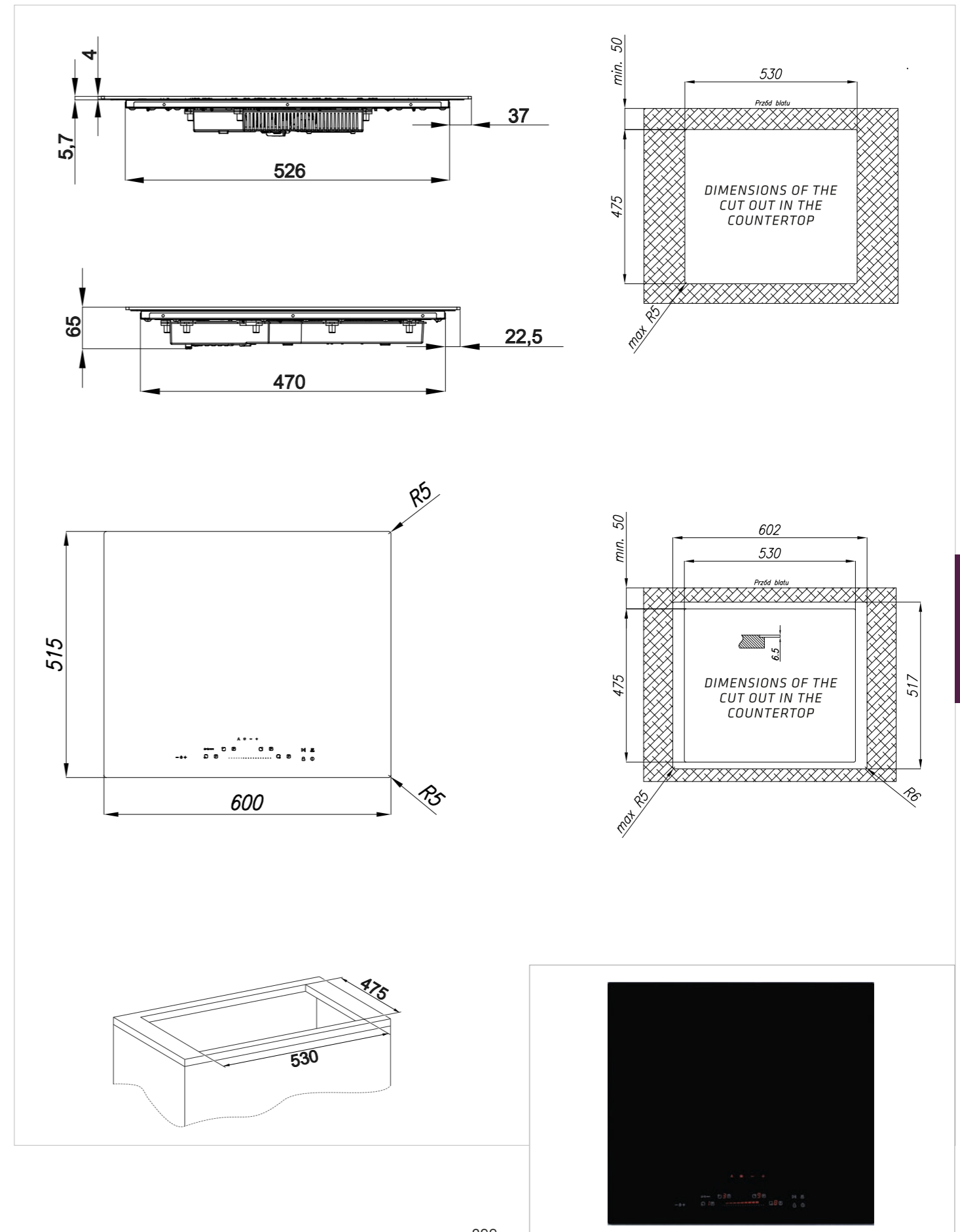



Technical drawing



CulinaSync Ultimate

induction hob

It is an **intelligent control centre for the kitchen**, equipped with **Cook Assist automatic extractor synchronization technology**. Advanced **Bridge cooking zones** allow you to **combine zones for larger cookware**, offering **complete freedom when preparing multi-component dishes**. The **premium black ceramic glass finish** gives the appliance a **distinctly prestigious look**, perfectly complementing **modern kitchen designs**.

	5-zone hob
	Flush installation
	Automatic cooking programs
	Touch display
	Cook Assist
	Bridge









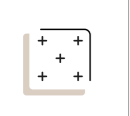

CulinaSync Ultimate

induction hob

Basic specifications

Dimensions (H x W x D)	56 x 775 x 520 mm
Number of cooking zones	5
Total power	7200 W
Zone power	3x 2200 W, 2x 1200 W
Bridge zones	Yes, 1x
User safety	Button lock, Child Lock
Automatic cooking programs	Yes
Cook Assist – automatic extractor control	Yes
Timer	Yes
Boost	Yes
Flush installation	Yes
Control type	Touch control, TFT display
Control color	Multicolor
Finish	Black
Net weight	12,5 kg

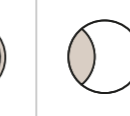
Technologies

							
5-zone hob	Flush installation	Automatic cooking programs	Touch display	Cook Assist	Timer	Bridge	Boost



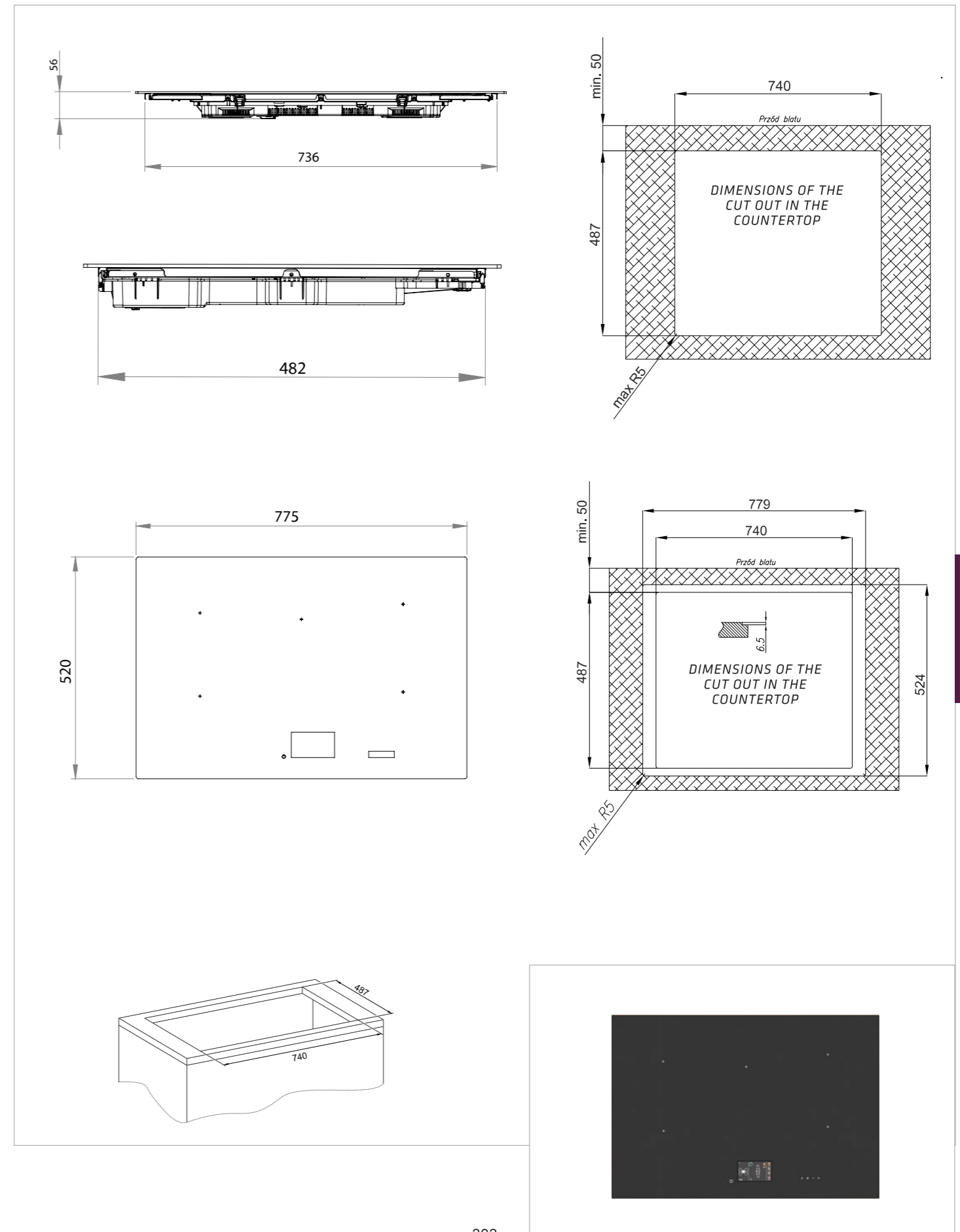



Technical drawing



CulinaSync Advanced Matte

induction hob

It stands out with a **deep matte ceramic glass finish** that not only gives the kitchen a **luxurious character**, but is also **highly resistant to scratches and smudges**. Equipped with **intelligent extractor communication and precise slider control**, it allows for **instant power adjustment of the cooking zones**. Thanks to the **Bridge function**, which connects cooking zones, the hob offers complete freedom when **using large cookware**, while maintaining **impeccable aesthetics at all times**.

	Matte surface
	Flush installation
	Slider
	Cook Assist
	Bridge
	Boost









CulinaSync Advanced Matte

induction hob

Basic specifications

Dimensions (H x W x D)	65 x 600 x 515 mm
Number of cooking zones	4
Total power	7200 W
Zone power	3x 2000 W, 1x 1600 W
Bridge zones	Yes,, 1x
User safety	Button lock, Child Lock
Automatic cooking programs	Yes
Cook Assist – automatic extractor control	Yes
Timer	Yes
Boost	Yes
Flush installation	Yes
Control type	Touch control, 1x slider
Control color	Red
Finish	Matte black
Net weight	8,25 kg

Technologies

						
Matte surface	Flush installation	Slider	Cook Assist	Timer	Bridge	Boost

Technical drawing

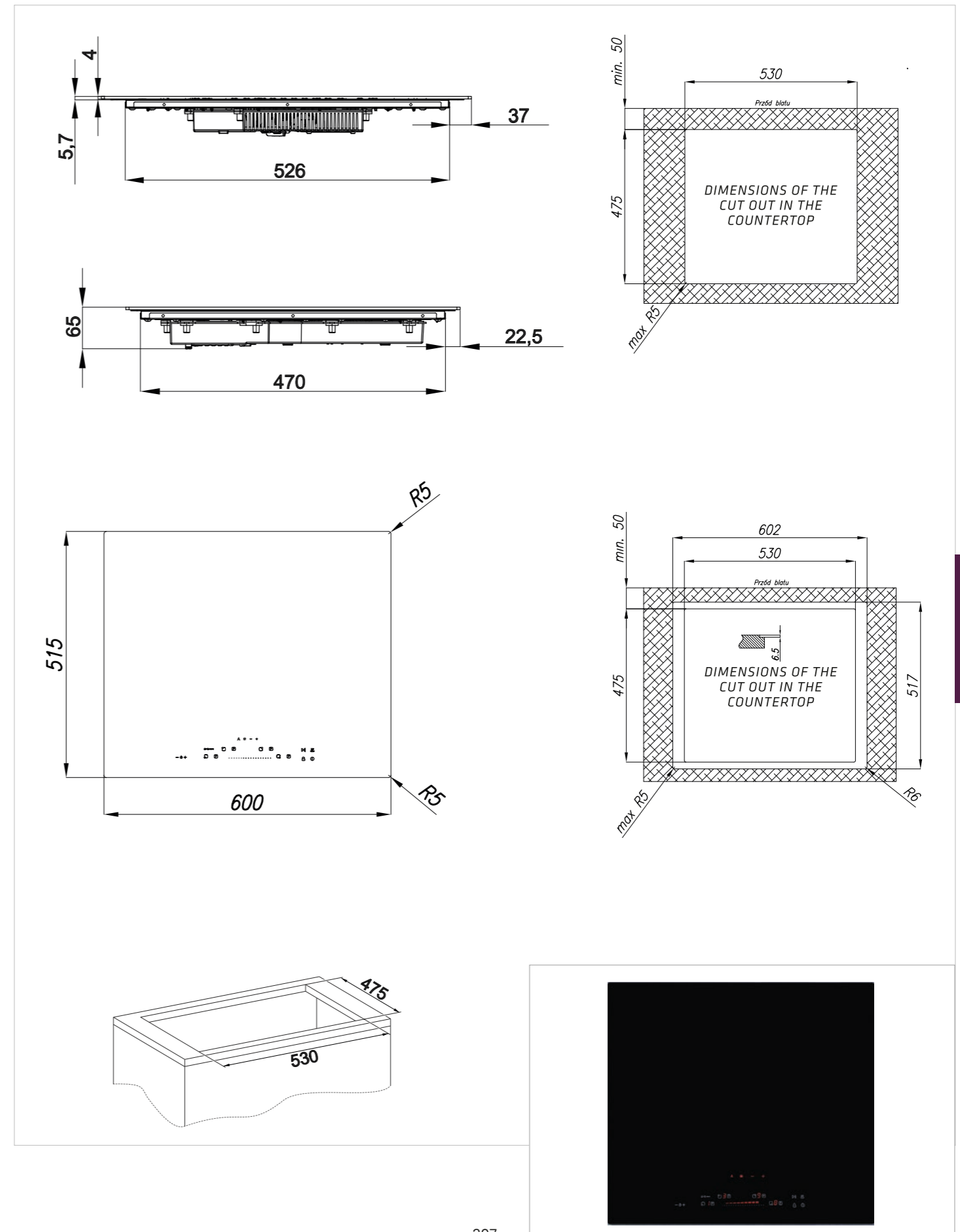

08

**NEW
PRODUCTS**



NEW

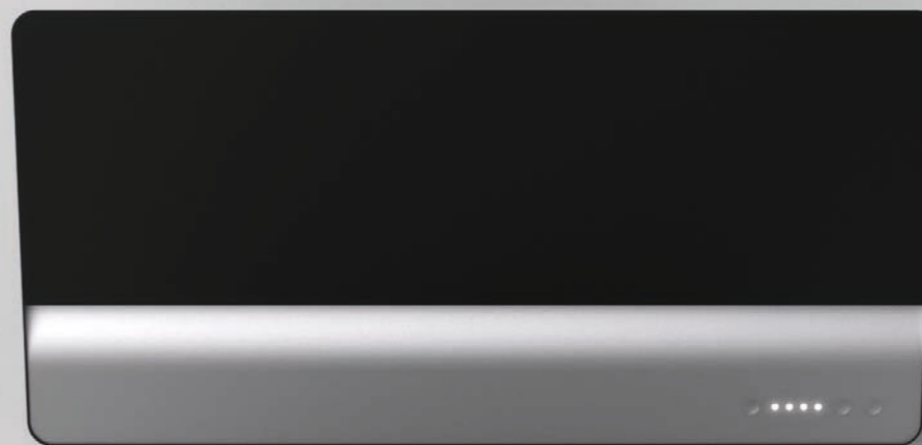

INLET
wall mounted hood

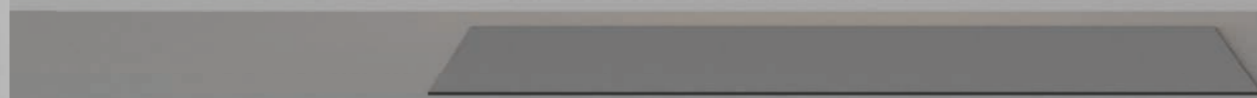



NEW

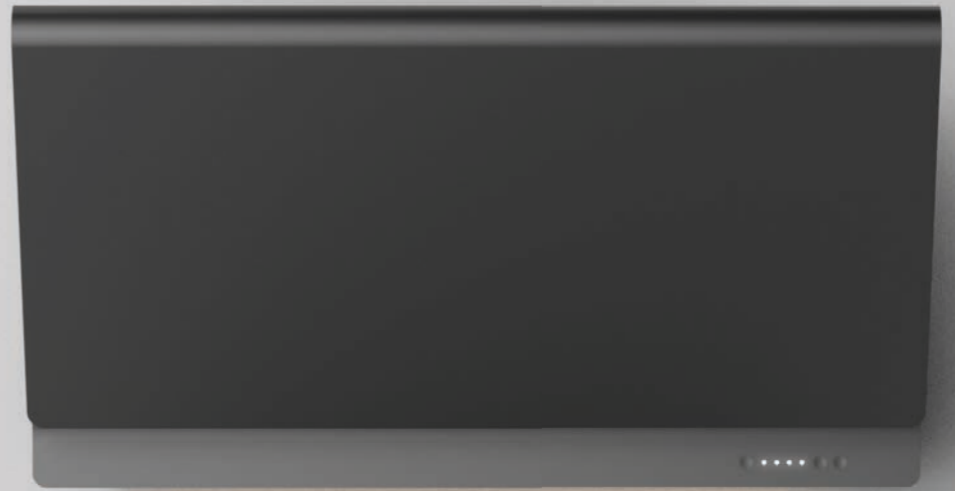

TACO
wall mounted hood



NEW

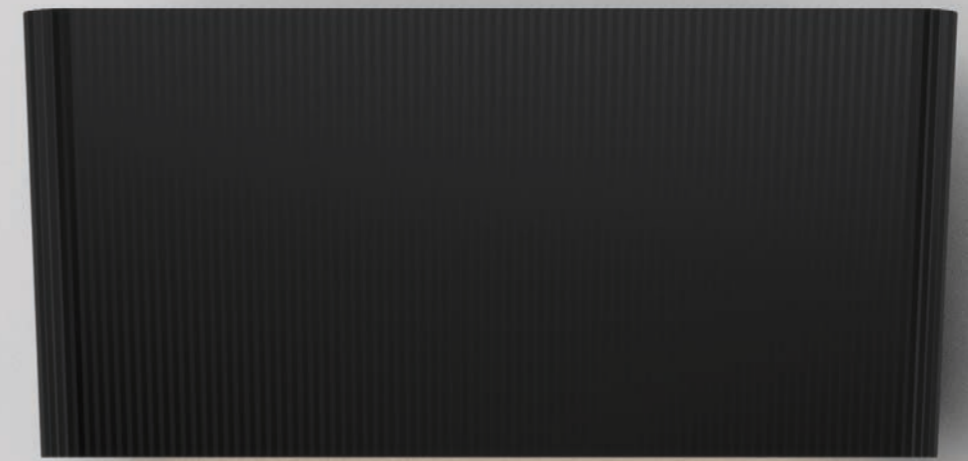
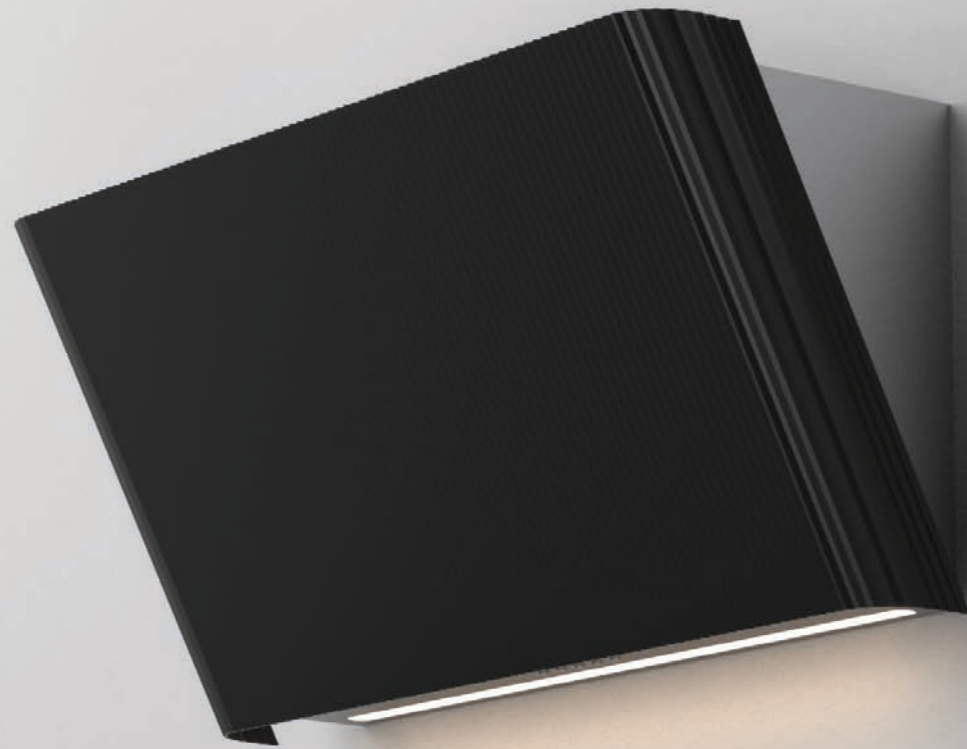

MONO S
wall mounted hood



WIZARD ADVANCED

model integrated with induction hob



NEW

WIZARD OVAL
model integrated with induction hob

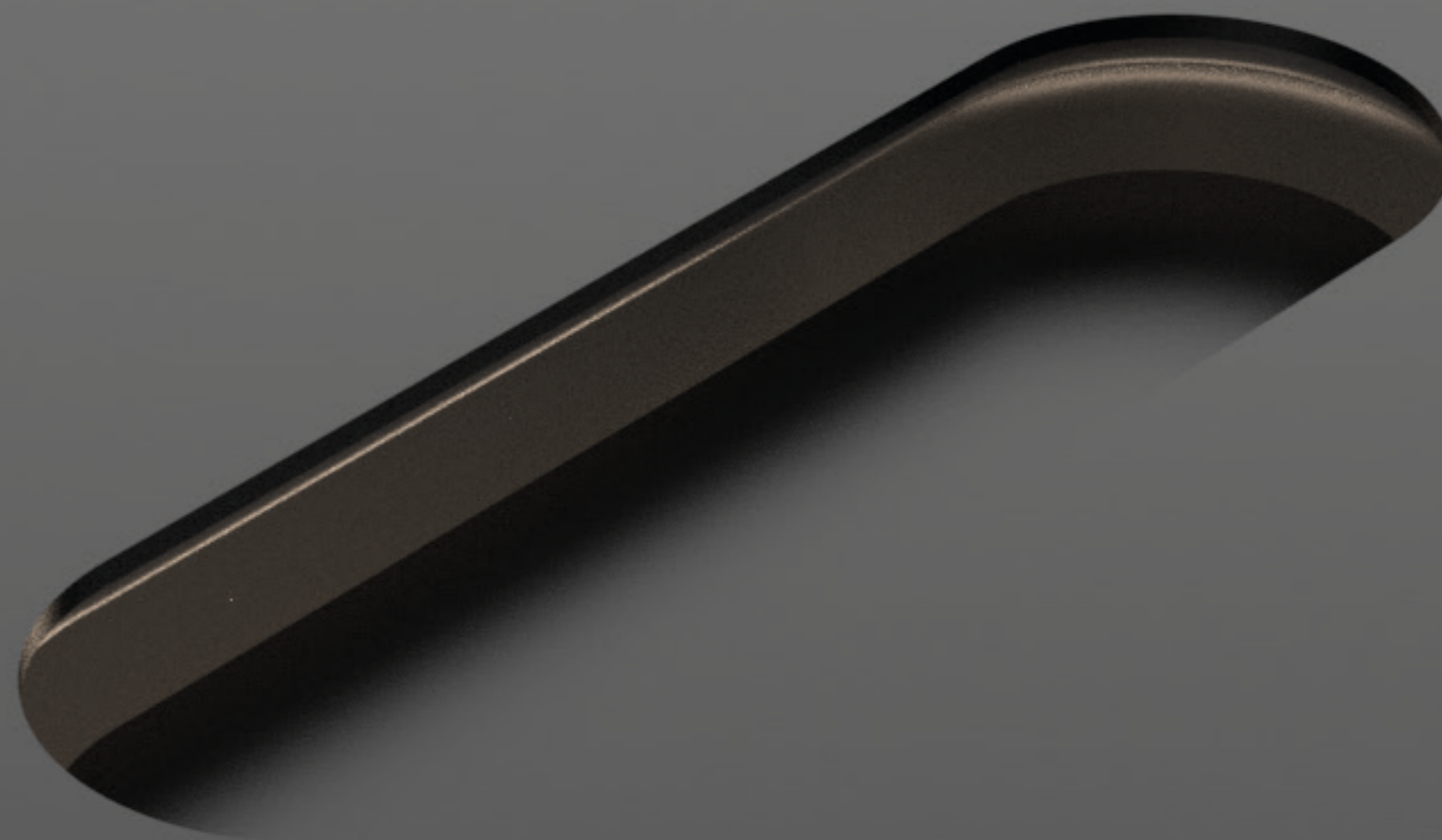

NEW

09

ACCESSORIES







carbon filters

HERE YOU WILL FIND FILTERS, DUCTS AND OTHER ACCESSORIES NEEDED FOR THE PROPER INSTALLATION AND OPERATION OF THE KITCHEN HOOD.

	<p>Filter FWN 185</p> <p>FOR HOODS: CUBE, MINIMAL 7, MINIMAL 8, SU MINI 60</p>		<p>Filter FWK 300</p> <p>FOR HOODS: MINIMAL 2 180 CM, T-LIGHT 60 CM, T-LIGHT 90 CM</p>
	<p>Filter FWK 228</p> <p>FOR HOODS: MISS W, ICONW, FLUO W, MONOGRAM, MONOGRAM W, ROTO, ROTO W, TUBUS, TUBUS W</p>		<p>Filter FWK 385</p> <p>FOR HOODS: AURA 55CM, DUO 55CM, JOKER DUO 55CM, JOKER UNO 55CM, UNO 55CM</p>
	<p>Filter FWK 280</p> <p>FOR HOODS: MINIMAL 2 120 CM, MOONDRAFT 90, TRIO</p>		<p>Filter FWK 485</p> <p>FOR HOODS: AURA 74CM, DUO 74CM, JOKER DUO 74CM, JOKER UNO 74CM, SU MINI 74CM, UNO 74CM</p>

filter long life

EQUIPPED WITH ACTIVATED CARBON, THEY HAVE A STRUCTURE WITH A HIGHER ACTIVE CARBON CONTENT THAN STANDARD FILTERS. THEIR SERVICE LIFE REACHES AROUND 3 YEARS, REQUIRING REGENERATION EVERY 4-6 MONTHS, WHICH CAN BE DONE BY WASHING THEM IN THE DISHWASHER.

	<p>Filter Long Life M1</p> <p>FOR HOOD: MINIMAL 1 / 90, MINIMAL 1 / 120</p>		<p>Filter Long Life M/S</p> <p>FOR HOOD: MONO 60 / MONO 80 / SIMPLE</p>
	<p>Filter Long Life M3</p> <p>FOR HOOD: MINIMAL 3</p>		<p>Filter Long Life 228</p> <p>FOR HOODS: MISS W, ICON W, FLUO W, MONOGRAM, MONOGRAM W, ROTO, ROTO W, TUBUS, TUBUS W</p>
	<p>Filter Long Life M4</p> <p>FOR HOODS: MINIMAL 4 60CM, MINIMAL 5 60CM</p>		<p>Filter Long Life 385</p> <p>FOR HOODS: AURA 55 CM, DUO 55 CM, JOKER DUO 55 CM, JOKER UNO 55 CM, UNO 55 CM</p>













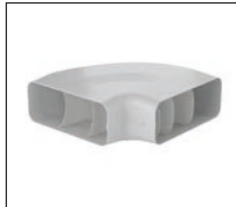

	<p>Filter Long Life M6/60</p> <p>FOR HOODS: MINIMAL 6 90 CM, MINIMAL 4 90 CM, MINIMAL 5 90 CM, MINIMAL 6 60 CM</p>		<p>Filter Long Life M/P</p> <p>FOR HOODS: MONO LIGHT, PIU LIGHT</p>
	<p>Filter Long Life E</p> <p>FOR HOOD: ECLIPSE</p>		<p>Filter Long Life 485</p> <p>FOR HOODS: AURA 74 CM, DUO 74 CM, JOKER DUO 74 CM, JOKER UNO 74 CM, SU MINI 74 CM, UNO 74 CM</p>
	<p>Filter Long Life 150</p> <p>FOR HOOD: MOONDRAFT 60 CM</p>		<p>Filter Long Life M/W</p> <p>FOR HOOD: MONO W</p>
	<p>Filter Long Life 280</p> <p>FOR HOODS: MINIMAL 2 120 CM, MOONDRAFT 90 CM, TRIO</p>		<p>Grease filter Long Life Wizard 2.0 + filter holder (set)</p>
	<p>Filter Long Life 300</p> <p>FOR HOODS: MINIMAL 2 180 CM, T-LIGHT 60 CM, T-LIGHT 90 CM</p>		<p>Grease filter Long Life Wizard One - 2 pieces + filter holder (set)</p>
	<p>Filter Long Life 467</p> <p>FOR HOOD: SU MINI 60 CM</p>		<p>Grease filter Long Life Wizard Slim - 2 pieces + filter holder (set)</p>

space MAX wizard and max space joker

	<p>SpaceMax Wizard</p> <p>FOR: WIZARD 2.0, WIZARD ONE, WIZARD SLIM, WIZARDMATTE 83, WIZARD SLIM MATTE, WIZARD ADVANCED, WIZARD OVAL</p>		<p>SpaceMax Joker white/black</p> <p>FOR HOODS: UNO JOKER, DUO JOKER</p>
---	--	---	---

accessories

THE HIGHEST QUALITY DUCTS, ASSEMBLED USING FLEXIBLE CONNECTORS WITH INTEGRATED SEALS, ENSURING TIGHTNESS IN ACCORDANCE WITH HIGH ATC3 CLASS STANDARDS AND WITH A SYSTEM ENABLING SMOOTH ANGLE ADJUSTMENT IN THE RANGE OF 0-15 DEGREES.







	Round channel ø 150 mm, L= 1000 mm		Round knee 90° connectors ø 150 mm to flat 222x89 mm
	Flat channel 222x89 mm, L=1000 mm		Short channel connector round ø 150 mm with a flat channel 222x89mm
	Knee flat horizontal 90° 222x89mm		Channel connector round ø 150 mm with a flat channel 222x89mm
	Knee flat horizontal 30° 222x89 mm		Flexible connector (up to 15°) flat ducts 222x89 mm
	90° round elbow ø 150 mm		Flexible connector (up to 15°) round ducts ø 150 mm
	Knee flat vertical short 90° 222x89 mm (dedicated to shallow cabinets)		Flexible handle to the round channel ø 150 mm
	Knee flat vertical 90° 222x89mm		Wall channel with the Thermobox system entrance ø 150 mm, round grille, stainless steel

accessories

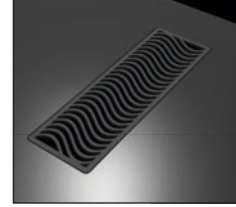
HERE YOU WILL FIND FILTERS, DUCTS AND OTHER ACCESSORIES NEEDED FOR THE PROPER INSTALLATION AND OPERATION OF THE KITCHEN HOOD.

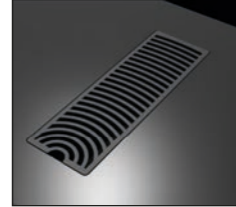
	Grille ventilation stainless steel 297x150 mm		Canal flexible 222x89 mm, L = 250-550 mm
	Grille ventilation black matt 297x150 mm		OutVent External Attic-Mounted Motor
	Kit for mouning motor outside the hood. For: Moondraft		Kit for mounting motor outside the hood. For: Su Frame, Su Light

decorative accessories

	Decorative frame Wizard 2.0 #1 AVAILABLE COLORS: ● ● ●		Decorative frame Wizard Slim #1 AVAILABLE COLORS: ● ● ●
	Decorative frame Wizard 2.0 #2 AVAILABLE COLORS: ● ● ●		Decorative frame Wizard Slim #2 AVAILABLE COLORS: ● ● ●
	Decorative frame Wizard 2.0 #3 AVAILABLE COLORS: ● ● ●		Decorative frame Wizard Slim #3 AVAILABLE COLORS: ● ● ●
	Decorative frame Wizard One AVAILABLE COLORS: ●		



Plac Konesera 6, lok. U2B,
03-736 Warszawa



Scan to explore more on
our website.



Scan to explore **Monno**
on Instagram.